

# HAWK ENTERPRISES

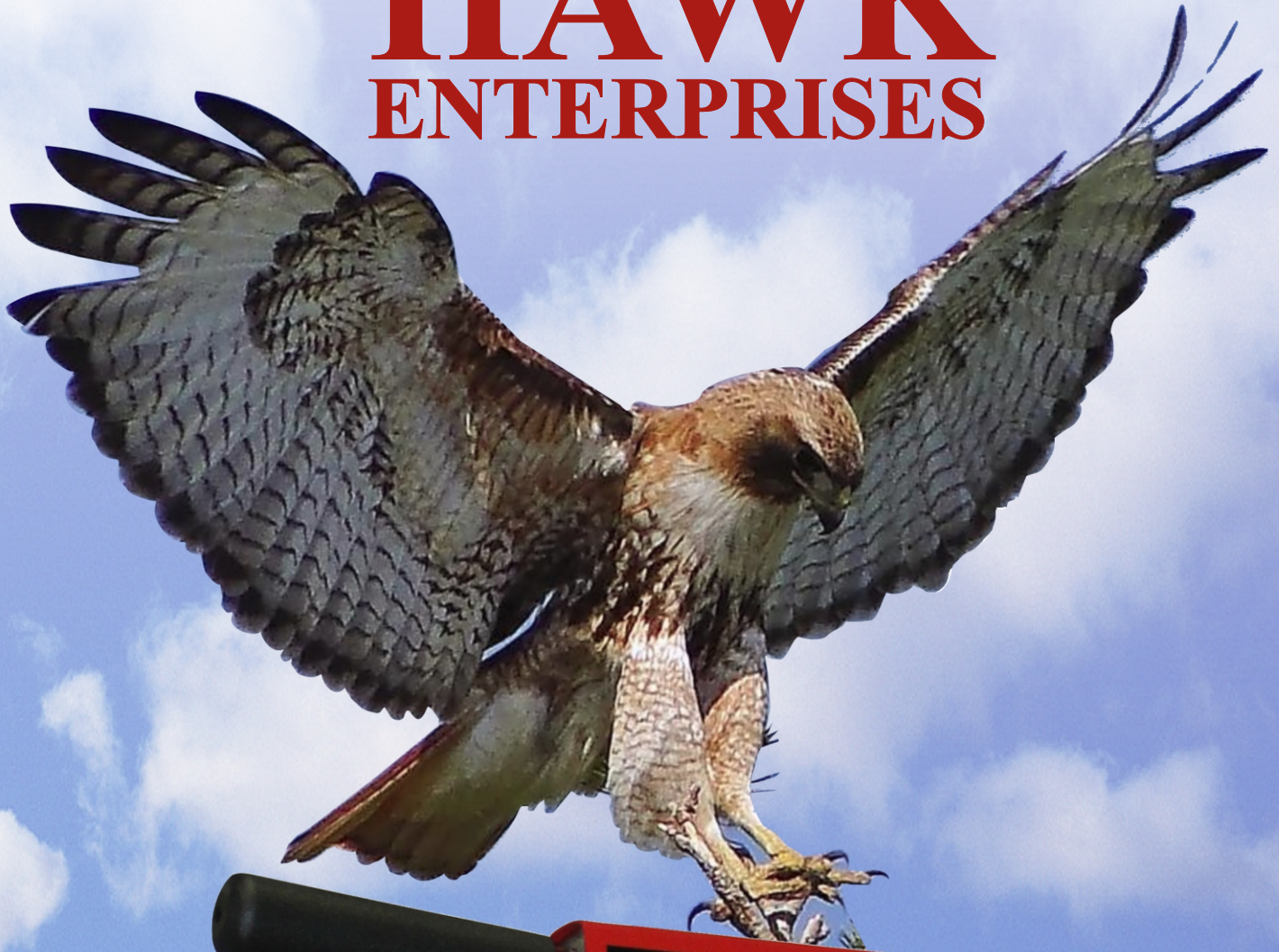

**HAWK**

ELKHART, IN USA  
574-294-1910  
[www.hawken enterprises.com](http://www.hawken enterprises.com)

**Rotary Floor Machines • Orbital Floor Machines**

HAWK ENTERPRISES

2902 Park Six Court, Elkhart, IN

**Burnishers • Cleaning Equipment**

(574) 294-1910 [www.hawken enterprises.com](http://www.hawken enterprises.com)





## Your Reliable Source



Hawk has been designing and building high quality floor machines and specialty equipment in Elkhart, IN since 1995.

Hawk is an innovator in development of orbital floor machine technology. We currently offer five platforms of orbital equipment, making Hawk a leader in the industry.

Breakthrough technology continues with our exclusive "Floating Head" WD™ detachable handle machines. The results are substantial improvements in productivity and user safety. WD™ handles are now available on both rotary and orbital floor machines.

When it comes to custom design and private branding, look no further. No other machine manufacturer offers more choices, lower minimums or greater value than Hawk Enterprises.

## Discover the Hawk Line

### Floor Machines

Mighty Mini 10 .....	4
Mighty 13, 15 .....	5
Mighty 17,20 .....	6
HD, XHD.....	7
HD 2-Speed, XHD 2-Speed .....	8
BRUTE Severe Duty .....	9
BRUTE 360 .....	10
Pro Floor Restoration Machine .....	11
GP26 .....	12
WS30 ..	13

### Floating Head Floor Machines

Glide Freedom, Glide XHD .....	14
Glide Freedom 2-Speed.....	15
Glide Sanding Star .....	16
Merlin .....	17
Merlin 2-Speed XHD .....	18
Merlin 360 .....	19

### Orbital Floor Machines

G2 Raptor .....	20
TigerHawk 1410 .....	21
TigerHawk 2014, 2814 .....	22
RedTail 2014-180 .....	23

### High Speed Burnishers

High-Speed - DC Motor .....	24
High-Speed - AC Motor .....	25
Centerfold High Speed .....	26

### Black Hawk Machines

BlackHawk FM Rotary Floor Machines.....	27
BlackHawk 1250 High Speed Burnisher.....	28
BlackHawk 1500 High Speed Burnisher.....	29

### Air Movers

BVP25D Air Motor .....	30
BVP50 Air Motor .....	31
Industrial Air Mover .....	32
BPB25DA Axial Air Mover .....	33
BH25AD Axial Air Movers .....	34

### Vacuums

V20, 20 Gallon Tank Vacuum .....	35
Titan V29 & V55, 29 and 55 Gallon Tank Vacuum .....	36
Harrier Backpack Vacuum .....	37

### Specialty Equipment

Hot Shot Extractor .....	38
Flight Finish Applicator .....	39
Talon Edger Scrubber .....	40
Twin Talon Scrubber .....	41
Hawk Propane Burnisher.....	42

### Accessories

Claw Rotary Tool .....	43
Orbitec Rotary Tool .....	44
HAWK Scraper Tool .....	45
Rotary Floor Machine Accessories .....	46
Rotary Brushes & Pad Drivers .....	47
TigerHawk Orbital Floor Machine Accessories.....	48
Burnisher Accessories.....	49
Private Label Program .....	50







**HAWK Mighty Mini 10**  
Counter tops, Stairs,  
Hard Surfaces  
10"



**HAWK Mighty**  
Small Area Stripping,  
Scrubbing, Polishing  
13", 15"



**HAWK Mighty Global**  
Small Area Stripping,  
Scrubbing, Polishing  
17", 20"



**HAWK HD**  
General Duty  
Stripping & Scrubbing,  
13", 15", 17", 20"



**HAWK XHD**  
Xtra Duty Stripping,  
Scrubbing, Carpet  
Care  
13", 15", 17", 20"



**HAWK HD 2-Speed**  
General Duty  
Stripping, Buffing,  
Carpet Care  
13", 15", 17", 20"



**HAWK XHD 2-Speed**  
Xtra Duty Stripping,  
Buffing, Carpet Care  
13", 15", 17", 20"



**HAWK BRUTE,  
TE, TECP**  
Deluxe Severe Duty  
Stripping, Sanding,  
Resurfacing, Carpet  
Care  
13", 15", 17", 20"



**HAWK BRUTE 360**  
Severe Duty w/Dust  
Control  
Stripping, Sanding,  
Resurfacing  
17", 20"



**HAWK Pro**  
Professional Floor  
Restoration Machine  
17", 20"



**HAWK Glide Freedom**  
13", 15", 17", 20"  
**HAWK Glide Dual-Speed**  
17", 20"  
WD™ General Duty  
Floor & Carpet Care



**GP26**  
Wide Area Floor  
Machine  
26"  
Stripping, Scrubbing,



**HAWK WS30**  
All Surface Floor  
Restoration Machine  
30"



**HAWK Glide  
Sanding Star**  
Sanding and Grinding  
Wet & Dry  
17", 20"



**HAWK Merlin &  
HAWK Merlin 2-Speed**  
Severe Duty  
Heavy-Weight WD™  
Strip, Scarify, Scrap,  
Polish 17", 20"



**HAWK Merlin 360**  
Severe Duty with Dust  
Pickup, WD™ Stripping,  
Sanding Resurfacing  
17", 20"



**HAWK G2 Raptor**  
Orbital Floor Machine  
Scrubbing, Wet/Dry  
Stripping  
1740 RPM - 20"x14"



**HAWK 1410**  
Small Area Orbital  
Floor Machine  
1725 RPM  
14"x10"



**HAWK 2014**  
Deluxe Orbital  
Floor Machine  
1740 RPM  
20"x14"



**HAWK 2814**  
Wide Area Orbital  
Floor Machine  
1740 RPM  
28"x14"



**HAWK RedTail  
2014-180**  
Surface Prep  
Orbital Floor Machine  
1740 RPM



**HAWK High Speed  
DC Motor**  
13", 15", 17", 20"  
**High Speed  
AC Motor**  
13", 15", 17"



**HAWK High Speed  
Centerfold Burnishers**  
DC Motor - 3 Speeds  
13", 15", 17", 20"



**BlackHawk 175 (17,20")**  
**BlackHawk 1500 (20")**  
**BlackHawk 1250 (20")**  
Private Label  
Equipment





## Counter Tops, Stairs, Small Spaces

The performance, versatility and value of the HAWK Mighty continues with the new Mighty Mini 10. The 1.0 HP TEFC (Totally Enclosed Fan cooled) AC motor drives 10" rotary brush with risers or 9" pads with pad driver. Ample power in a small and manageable machine. Excellent balance with low center of gravity. Ideal for use in tight spaces, restrooms, edging and stairs.

The innovative design of HAWK Mighty machines incorporates a state of the art "World Motor". Works around the globe without modification.

### Power

- 1.0 HP, TEFC AC motor
- 115-230V, 50/60 Hz power
- 50 ft., (14-3) 2-piece commercial power cord with cord lock for rigid handle models

### Engineering

- Triple-planetary severe-duty 11:1 helical-cut industrial gears, case hardened with steel coupler
- Gears drive brushes and pads at 165 RPM
- All steel construction with welded, powder-coated frame
- 3 steel handle options - standard 48", short 24" and telescoping 36" - 48". All with 6-position pin lock
- Comfortable vinyl dipped foam handle grips
- Thumb-operated safety switch. Negative pressure on/off switch
- Dual steel operating triggers.
- 1" x 5" non-marking ball bearing wheels
- Optional dust collection kit
- Optional handle mounted cord wrap (#KIT3009-1BLK)

### Safety Features

- Quiet 64 dB operation. Meets GS42 standard.
- Built with UL Listed components



Mighty Mini 10  
w/ 48" Handle

Mighty Mini 10-24  
w/ 24" Handle

Mighty Mini 10-TH  
w/ Telescoping Handle



## Specifications

Model	Mighty Mini 10	Mighty Mini 10-TH	Mighty Mini 10-24
Item #	F60-10	F60-10TH	F60-10-24
Pad Driver Size	9"	9" 9"	
Brush with Riser	10"	10"10"	
Handle	48"	36" - 48"	24" 1-piece
	Rigid/Short	Telescoping	Rigid / Short
Speed	165 RPM	165 RPM	165 RPM
Draw	5.9 Amp	5.9 Amp	5.9 Amp
Weight	71 lbs.	70 lbs.	69 lbs.

### All Models

Motor	1.0 HP, 56 frame, dual capacitor AC motor
Power Source	115-230V, 50/60 Hz power
Power Cord	50 ft., (14-3) 2-piece commercial with cord lock
Driver System	Triple-planetary XHD 11:1 helical-cut industrial gears
Sound Level (ave.)	64 dB - Meets GS 42 Standard

Subject to Change Without Notice



Works in  
Tight Spaces



Low Rise Profile - Easy  
Working Under Sinks  
and Partitions



Handle with 6-Position  
Pin Lock



Telescoping Handle  
Adjusts from 36" to 48"





### Stripping, Scrubbing, Polishing

Machine operators will appreciate the performance, versatility and value in the HAWH Mighty. The 1.0 HP TEFC (Totally Enclosed Fan Cooled) AC motor and XHD gears deliver huge power in a small and manageable machine. The Mighty is ideal for use in tight spaces, restrooms, edging and stairs.

The HAWK Mighty innovative design incorporates a state of the art "World Motor" works around the globe without modification .

#### Power

- 1.0 HP, TEFC AC Motor
- 115-230V, 50/60 Hz power
- 50 ft., (14-3) 2-piece commercial power cord with cord lock

#### Drive System

- Triple-planetary severe-duty 11:1 helical-cut industrial gears, case hardened with steel coupler
- Gears drive brushes and pads at 165 RPM

#### Engineered Design

- All steel construction with welded, powder-coated frame
- Telescoping handle (TH models) adjusts from 36" to 48"
- Brush covers have full wraparound bumper
- One piece powder-coated, heavy-duty steel handle with 6-position pin lock
- Comfortable vinyl dipped foam handle grips
- Thumb-operated safety switch. Negative pressure on/off switch
- Dual steel operating triggers
- 1" x 5" non-marking ball bearing wheels
- Optional dust collection kit
- Optional handle mounted cord wrap (#KIT3009-1BLK)
- Optional 4 gallon solution tank (#A0001-Color4)

#### Safety Features

- Quiet 64 dB operation. Meets GS42 standard.
- Built with UL Listed components



### Specifications

Model	MIGHTY 13	MIGHTY 13-TH	MIGHTY 15	MIGHTY 15-TH
Item #	F60-13	F60-13TH	F60-15	F60-15TH
Handle	Rigid	Telescoping	Rigid	Telescoping
Size	13"	13"	15"	15"
Pad Size	12"	12"	14"	14"
Pad Speed	165 RPM	165 RPM	165 RPM	165 RPM
Amp Draw	4.9	4.9	6	6
Weight	87 lbs.	87 lbs.	88 lbs.	88 lbs.

### All Models

Motor	1.0 HP, TEFC AC
Power Source	115-230V, 50/60 Hz
Power Cord	50 ft., (14-3) 2-piece commercial with cord lock
Gear Box	Triple-planetary XHD 11:1 helical-cut industrial
Sound Level (ave.)	64 dB - Meets GS42 standard

Subject to Change Without Notice



Works in Tight Spaces



Telescoping Handle Adjusts from 36" to 48"

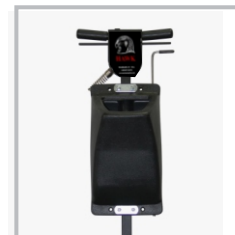

Optional 2.5-Gallon Solution Tank



Handle with 6-Position Pin Lock





## Stripping, Scrubbing, Polishing

Machine operators will appreciate the performance, versatility and value of the HAWK Mighty. The 1.0 HP TEFC (Totally Enclosed Fan Cooled) AC motor and XHD gears deliver huge power in a small and manageable machine. Use the 17" or 20" Mighty for the big jobs.

The HAWK Mighty innovative design incorporates a state of the art "World Motor". Works around the globe without modification .

### Power

- 1.0 HP, TEFC AC motor
- 115-230V, 50/60 Hz power
- 50 ft., (14-3) 2-piece commercial power cord with cord lock

### Drive System

- Triple-planetary, severe-duty 11:1 helical-cut industrial gears, case hardened with steel coupler
- Gears drive brushes and pads at 165 RPM

### Engineered Design

- All steel construction with welded, powder-coated frame
- 17" and 20" steel brush covers with wraparound bumper
- One piece powder-coated, heavy-duty steel handle with 4-position pin lock
- Comfortable vinyl-dipped foam handle grips
- Thumb-operated safety switch
- Negative pressure on/off switch. Dual steel operating triggers
- 1" x 5" non-marking ball bearing wheels
- Optional dust collection kit
- Optional 2.5 gallon solution tank (#A0001-BLK25)
- Optional 4 gallon solution tank (#A0001-Color4)
- Optional handle mounted cord wrap (#KIT3009-1BLK)

### Safety Features

- Quiet 64 dB operation. Meets GS42 standard.
- Built with UL Listed components



Optional Cord Wrap Hook



ELKHART, IN



## Specifications

	Mighty 17	Mighty 20
<b>Model</b>	Mighty 17	Mighty 20
<b>Item #</b>	F60-17	F60-20
<b>Size</b>	17"	20"
<b>Pad Size</b>	16"	19"
<b>Speed</b>	165 RPM	165 RPM
<b>Amp Draw</b>	7 Amp	8 Amp
<b>Weight</b>	90 lbs.	93 lbs.
<b>All Models</b>		
<b>Motor</b>	1.0 HP, TEFC AC	
<b>Power Source</b>	115-230V, 50/60 Hz	
<b>Power Cord</b>	50 ft., (14-3) 2-piece commercial with cord lock	
<b>Gear Box</b>	Triple-planetary XHD 11:1 industrial	
<b>Sound Level (ave.)</b>	64 dB - Meets GS42 standard	

Subject to Change Without Notice



Handle with 4-Position Pin Lock

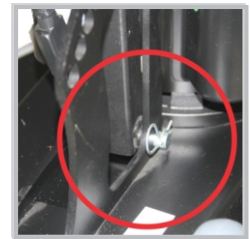

Remove the Handle Mounting Pin w/o Tools



Optional 2.5-Gallon Solution Tank



Two Piece (14-3) Pig-Tail Cord w/ Molded



### Stripping, Scrubbing, Carpet Care

The HAWK HD and HAWK XHD ruggedly reliable floor machines, powered by the 1.5 HP twin capacitor AC motor. Professional users select the standard HD to scrub at 175 RPM. For extra power, use the XHD with heavier gears and more torque to drive floor tools. Both are offered with a wide range of tools, accessories and optional weights.

#### Power

- 1.5 HP, AC Motor, 115-230V, 60 HZ, (50 HZ optional)
- 115-230 V, 60 Hz, (50 Hz optional)
- 50 ft., (14-3) 2-piece commercial power cord with cord lock
- **HD** uses triple-planetary HD 10:1 helical-cut commercial gears. Drives brushes and pads at 175 RPM
- **XHD** (Extra Heavy Duty) planetary 11:1 helical-cut industrial gears, case hardened with steel coupler. Drives brushes and pads at 165 RPM

#### Engineered Design

- All steel construction with welded, powder-coated frame
- One piece, chrome plated heavy-duty steel handle with variable position handle lock and vinyl-dipped foam grips
- Powder-coated steel brush covers with full wraparound bumpers
- Dual steel operating triggers. Negative pressure on/off switch
- Thumb-operated safety switch. 1" x 5" non-marking wheels
- Optional frame weights (XHD only)
- Optional pad driver, solution tank and splash guard kit (**DX KIT**)
- Optional 4 gallon solution tank (**#A0001-Color4**) 7 colors

#### Safety Features

- Quiet 60dB (HD) and 66 dB (XHD) operation. Meets GS42 Standard.
- UL / CUL listed



Welded Steel Frame, Handle and Brush Cover



XHD Machine Has 11:1 Gears



DX Kit Includes Pad Driver, Solution Tank &



Brush Covers in 7 Stock Colors Plus Chrome



#### Specifications HD

#### Specifications XHD

	HP-1513-HD	HP-1515-HD	HP-1517-HD	HP-15203-HD	HP-1513-XHD	HP-1515-XHD	HP-1517-XHD	HP-15203-XHD
<b>Model</b>	HP-1513-HD	HP-1515-HD	HP-1517-HD	HP-15203-HD	HP-1513-XHD	HP-1515-XHD	HP-1517-XHD	HP-15203-XHD
<b>Item #</b>	F03-13-01	F03-15-01	F03-17-01	F03-20-01	F04-13-01	F04-15-01	F04-17-01	F04-20-01
<b>Size</b>	13"	15"	17"	20"	13"	15"	17"	20"
<b>Pad Size</b>	12"	14"	16"	19"	12"	14"	16"	19"
<b>Pad Speed</b>	175 RPM	175 RPM	175 RPM	175 RPM	165 RPM	165 RPM	165 RPM	165 RPM
<b>Amp Draw</b>	5.5	5.7	5.9	6.5	5.3	5.6	6.1	6.8
<b>Weight</b>	87 lbs	91 lbs	94 lbs	97 lbs	87 lbs	91 lbs	94 lbs	97 lbs
<b>All HD Models</b>					<b>All XHD Models</b>			
<b>Motor</b>	1.5 HP, DC rectified				1.5 HP, DC rectified			
<b>Motor Cover</b>	Powder-Coated				Chrome			
<b>Drive Gears</b>	Triple-planetary 10:1 commercial				Triple-planetary XHD 11:1 industrial			
<b>Power Source</b>	115V, 50/60 Hz (230V Optional)				115V, 50/60 Hz (230V optional)			
<b>Power Cord</b>	50 ft., (14-3) 2-pc. commercial w/cord lock				50 ft., (12-3) 2-pc. industrial with cord lock			
<b>Sound Level</b>	60dB (175) - 69dB (320) Meets GS42				69dB(165) - 72dB (300) Meets GS42			

Subject to Change Without Notice





**ENTERPRISES**

# HAWK HD & XHD 2-Speed Professional Floor Machines

## Stripping, Scrubbing, Carpet Care

The HAWK HD 2-Speed and HAWK XHD 2-Speed floor machines are tough and versatile. Change between low and high speed as the job requires. Powered by a 1.5 HP DC rectified motor.

Choose the HD for standard scrubbing and stripping at 175/320 RPM. The XHD model uses 11:1 helical cut gear set for more challenging work including carpet care and natural stone maintenance. XHD models can bear extra weights for greater down pressure and faster results.

### Power

- 1.5 HP, DC rectified 2-speed motor.
- 115V, 50/60 Hz power (230V optional)
- **HD 2-Speed** uses triple-planetary 10:1 helical-cut commercial gears. Drives brushes and pads at 175/320 RPM.
- **HD-2-Speed Cord** - 50 ft., (14-3) 2-piece commercial with cord lock
- **XHD 2-Speed** (Extra Heavy Duty) planetary 11:1 helical-cut industrial gears, case hardened with steel coupler. Chrome plated motor cover. 165/300 RPM pad speed.
- **XHD 2-Speed Cord** - 50 ft., (12-3) 2-piece industrial with cord lock
- Hi/Low speed switch is conveniently located on switch box handle

### Engineered Design

- All steel construction with welded, powder-coated frame
- One piece, chrome plated heavy-duty steel handle with variable position lock and vinyl-dipped foam grips
- Powder-coated steel brush covers with full wraparound bumpers
- Dual steel operating triggers. Negative pressure on/off switch
- Thumb-operated safety switch. 1" x 5" non-marking wheels.
- Optional frame weights for XHD only
- Optional DX kit includes solution tank, pad driver, splash guard

### Safety Features

- Quiet 60dB (HD 2-Speed) and 66 dB (XHD 2-Speed) operation. Meets GS 42 Standard.
- UL / CUL listed

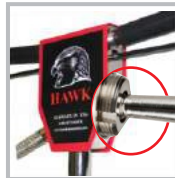

Meets GS42 standard



Easy Transport 1"x5" Non-Marking Wheels



DX Package w/ Solution Tank, Pad Driver & Splash Guard



### Specifications HD 2-Speed

Model	HD-2 Spd-13	HD-2 Spd-15	HD-2 Spd-17	HD-2 Spd-20
Item #	F03-13-01	F03-15-01	F03-17-01	F03-20-01
Size	13"	15"	17"	20"
Pad Size	12"	14"	16"	19"
Amp Draw	7.8 / 8.2	8.1 / 8.5	8.5 / 9.1	9.2 / 9.5
Weight	87 lbs	91 lbs	94 lbs	97 lbs

### Specifications XHD 2-Speed

Model	XHD-2 Spd-13	XHD-2 Spd-15	XHD-2 Spd-17	XHD-2 Spd-20
Item #	F04-13-01	F04-15-01	F04-17-01	F04-20-01
Size	13"	15"	17"	20"
Pad Size	12"	14"	16"	19"
Amp Draw	7.8 / 8.2	8.1 / 8.5	8.5 / 9.1	9.2/9.5 Amp
Weight	87 lbs	91 lbs	94 lbs	97 lbs

### All HD 2-Speed Models

Motor	1.5 HP, DC rectified 2-speed
Drive Gears	Triple-planetary 10:1 commercial
Pad Speed	175/320 RPM
Power Source	115V, 50/60 Hz (230V Optional)
Power Cord	50 ft., (14-3) 2-pc. commercial w/cord lock
Sound Level	60dB (175) - 69dB (320) Meets GS42 standard

### All XHD 2-Speed Models

Motor	1.5 HP, DC rectified 2-speed
Drive Gears	Triple-planetary XHD 11:1 industrial
Pad Speed	165/300 RPM
Power Source	115V, 50/60 Hz (230V optional)
Power Cord	50 ft., (12-3) 2-pc. industrial with cord lock
Sound Level	69dB(165) - 72dB (300) Meets GS42 standard

Subject to Change Without Notice



## Stripping, Sanding, Carpet Care, Resurfacing



The BRUTE is built for high productivity in the harshest jobs like concrete resurfacing, natural stone polishing, wood screening and sanding. We fit the powerful 1.5 HP, 180 frame TEFC (Totally Enclosed Fan Cooled) AC motor with 11:1 gears and industrial grade steel coupler. You will power your BRUTE without blowing breakers and reducing down time. The 100% steel construction is accented with three exterior decorations:

- **BRUTE** - chrome motor and brush cover
- **BRUTE TECP** - chrome motor with powder coated brush cover
- **BRUTE TE** - powder-coated motor and brush cover

### Power

- 1.5 HP, 180 frame, TEFC AC motor
- 115-230 V, 60 Hz, (50 Hz optional)
- 50 ft., (12-3) 2-piece industrial power cord with cord lock

### Drive System

- Triple-planetary XHD 11:1 helical-cut industrial gears, case hardened with steel coupler, driving brushes at 165 RPM

### Engineered Design

- All steel welded construction
- Steel brush covers with full wraparound bumper
- One piece chrome, heavy-duty steel handle with variable position lock
- Dual steel operating triggers with negative pressure on/off switch
- Thumb-operated safety switch
- Comfortable vinyl-dipped foam handle grips
- 1" x 5" non-marking ball bearing wheels
- Optional 4 gallon solution tank (#A0001-Color4) 7 colors
- Optional frame weight (#A0300-1), horseshoe weight (#HPA0032-2P)

### Safety Features

- Quiet 66 dB operation. Meets GS42 standard.
- UL/CUL listed



Specifications				
Machine Size	13"	15"	17"	20"
Model Brute	-	<b>BRUTE-15</b>	<b>BRUTE-17</b>	<b>BRUTE-20</b>
Item #	-	F35-CP	F37-CP	F40-CP
Motor / Brush Cover	-	Chrome/Chrome	Chrome/Chrome	Chrome/Chrome
Model Brute TE	<b>TE-13</b>	<b>TE-15</b>	<b>TE-17</b>	<b>TE-20</b>
Item #	F33-01-B	F35-01-B	F37-01-B	F40-01-B
Motor Cover	Black	Black	Black	Black
Brush Cover	Powder-Coated	Powder-Coated	Powder-Coated	Powder-Coated
Model Brute TECP	<b>TECP-13</b>	-	<b>TECP-17</b>	<b>TECP-20</b>
Item #	F33-01-C	-	F37-01-C	F40-01-C
Motor Cover	Chrome	-	Chrome	Chrome
Brush Cover	Powder-Coated	-	Powder-Coated	Powder-Coated
Amp Draw	7.2	7.5	7.9	8.4
Weight	113 lbs.	117 lbs.	123 lbs.	125 lbs
All Sizes				
Motor	1.5 HP, 180 frame, TEFC dual capacitor AC motor			
Pad Speed	165 RPM			
Power	115-230V, 60 Hz power. (50 Hz optional)			
Power Cord	50 ft., (12-3) industrial with cord lock			
Drive Gears	Triple-planetary XHD 11:1 helical-cut industrial			
Sound Level (ave.)	66 dB - Meets GS42 standard			



Optional Dust Pickup System with Vacuum Connection



Optional (2) 25 lb. Horseshoe Weights (#HPA0032-2P)



7 Private Brand Colors Plus Chrome



Power for Claw, Orbitec, Scraper & Sanders





### Stripping, Sanding, Resurfacing & Polishing



Vacuum Hose Support Hook

Shown with  
Optional  
80#  
Weight Kit

The BRUTE 360 is built for high productivity in the harshest jobs like concrete resurfacing, natural stone polishing, and wood screening and sanding. Designed with the powerful 1.5 HP 180 frame, TEFC (Totally Enclosed Fan Cooled) AC motor fit with 11:1 hardened helical cut gears and an industrial grade steel coupler. This combination of motor and gears weighs 30 pounds more than a standard machine of similar size. Power to drive sandpaper drivers, diamond pad drivers, Claw, Scraper and Orbitec tools.

The machine is built with the HAWK 360 Dust Pickup System™, using a 16 gauge steel powder-coated brush cover with a 360 degree dust collecting duct and exhaust port connects to 1.5" and 2" vacuum hose. Remove the heaviest soils by adding the optional 50 lb. weight set with transport lock.

#### Power

- 1.5 HP, 180 frame, dual capacitor TEFC AC motor
- 115-230V, 60 Hz power (50 Hz optional)
- 50 ft., (12-3) 2-piece industrial power cord with twist lock
- Extra heavy-duty XHD steel helical-cut 11:1 gears with steel coupler

#### Engineered Design

- Proprietary HAWK 360 brush cover with wraparound dust guard picks up dusts and debris
- Extra heavy-duty steel handle with vacuum hose support
- Heavy-duty motor guard protects the motor from impact damage
- Dual steel operating triggers with negative pressure on/off switch
- Thumb-operated safety switch. Comfortable vinyl-dipped foam grips
- 2" x 6" non-marking, load bearing ball bearing wheels
- Optional (2) 25 lb. removable weight set with locking pins and transport lock (#A360-17-2 -17"), (#A360-20-2 - 20")
- Optional Osprey Sprayer Kit (#TH-1010)

#### Safety Features:

- Quiet 66 dB operation. Meets GS42 standard.
- UL/CUL listed



### Specifications

<b>Model Item #</b>	<b>BRUTE 360-Black-17</b> F38-B (Black)	<b>BRUTE 360-Black-20</b> F41-B (Black)
<b>Model Item #</b>	<b>BRUTE 360-Chrome-17</b> F38-C (Chrome)	<b>BRUTE 360-Chrome-20</b> F41-C (Chrome)
<b>Machine Size</b>	17 inch	20 inch
<b>Pad Size</b>	16 inch	19 inch
<b>Pad Speed</b>	165 RPM	165 RPM
<b>Amp Draw</b>	7.9 Amp	8.4 Amp
<b>Weight</b>	133 lbs.	135 lbs.

### All Sizes

<b>Motor</b>	1.5 HP, 180 frame, TEFC dual capacitor AC
<b>Power</b>	115-230V, 60 Hz power (50 Hz optional)
<b>Power Cord</b>	50 ft., (12-3) 2-piece industrial with twist lock
<b>Drive Gears</b>	Triple-planetary XHD 11:1 helical-cut industrial
<b>Sound Level (ave.)</b>	66 dB - Meets GS42 standard

Subject to Change Without Notice



The Handle-Mounted Hose Support Carries 1.5" and 2" Vacuum



Variable Handle Height Adjustment and Transport Lock



The Steel Brush Cover is Built with Ribbed Vacuum Port



360° Duct in the Brush Apron Directs Debris to the 2" Vacuum Port



## Stripping, Scrubbing, Resurfacing



The HAWK Pro is designed for the floor care professional. This severe-duty machine handles the range of tasks with the 180-frame TEFC (Totally Enclosed Fan Cooled) motor with hardened steel gears that drive scrapers, sanders and tools at 165 RPM. Power to drive sandpaper drivers, diamond pad drivers, Claw, Scraper, and Orbitec tools.

The HAWK Pro includes two removable 25 lb. weights mounted on the brush cover, a convenient upper handle lock, 3" wider handle, a no-spill solution tank, pad driver, and splash guard.

### Power

- 1.5 HP, 180 frame, TEFC AC motor
- 115-230 V, 60 Hz (50 Hz optional)
- 50 ft., (12-3) 2 piece industrial power cord with twist lock

### Drive System

- Triple-planetary XHD 11:1 helical-cut industrial gears, case hardened with steel coupler. Gears drive brushes and tools at 165 RPM

### Engineered Design

- All steel construction with welded, powder-coated frame
- Heavy-duty motor guard protects the motor from impact damage
- One piece chrome, heavy duty steel handle with variable position lock
- Ergonomic upper grip handle is 3" wider than standard for leverage. Comfortable vinyl-dipped foam grips
- 17" and 20" steel brush covers with full wraparound bumpers
- Dual steel operating triggers. Thumb operated safety switch
- Negative pressure on/off switch
- 1" x 5" non-marking ball bearing wheels
- Includes diamond driver, 4 gallon solution tank and splash guard
- Includes (2) 25 lb. weight set with mounting lock pins. Added weights give extra down pressure for faster results
- Optional dust pickup system (**#HP0031-DC17-BRUTEKIT**, **#HP0031-DC20-BRUTEKIT**)

### Safety Features

- Quiet 66 dB operation. Meets GS42 standard.
- UL/CUL listed



## Specifications

	PRO-17	PRO-20
<b>Model</b>	PRO-17	PRO-20
<b>Item #</b>	F37-03 PRO	F040-03 PRO
<b>Pad Size</b>	16"	19"
<b>Pad Speed</b>	165 RPM	165 RPM
<b>Amp Draw</b>	7.9 Amp	8.4 Amp
<b>Weight</b>	128 lbs.	130 lbs.

All Sizes	
<b>Motor</b>	1.5 HP, 180 frame, TEFC dual capacitor AC
<b>Power</b>	115-230V, 60 Hz power (50 Hz optional)
<b>Power Cord</b>	50 ft., (12-3) 2 piece industrial with twist lock
<b>Drive Gears</b>	Triple-planetary XHD 11:1 helical-cut industrial
<b>Sound Level (ave.)</b>	66 dB - Meets GS42 standard



The Handle-Mounted Hose Support Carries 1.5" and 2" Vacuum



Includes Diamond Pad Driver



Two-Piece Twist Lock Power Cord



Upper Handle Lock is Easy to Access





### Grind, Polish, Scrub



The HAWK GP26 dual motor floor surfacing machine is a high production, low fatigue machine for commercial floor technicians. Cover 26" per pass running on a minimum 115V, 20 ampere circuit. This innovative design incorporates a special AC 115-230V, 50/60 Hz motor that works around the globe without requiring modifications.

Use for grinding, polishing, and deep cleaning of concrete, natural stone, and other hard surfaces. Engineered to polish within 1/2" of walls. Operators can use the dual motor directional switch for navigating irregular surfaces with ease.

The two-piece design allows the handle-carriage to be easily separated from the dual motor head. This is advantageous when equipment needs transport in to hard to reach locations or those with restrictive access, such as basements or mezzanines.

Equipped with 6 gallon solution tank and electric pump for wet processes. Collar weights can be removed for lighter touch in polishing and transport.

#### Engineered Design

- Control Center is front & center to the operator
- 3-position handle for transport, operation and storage
- 120 lumen LED lights (2- Sides, 2 Forward)
- 50 ft., (12-3) 2-piece industrial power cord with twist lock
- 10"x2" grooved non-marking transport wheels
- Detachable handle-carriage for transport
- 6 Gallon solution tank with 60 PSI diaphragm pump
- Dual AC-TEFC motors with 11:1 XHD gears
- Removable collar weights
- Built in dust control with combo 1.5" or 2" exhaust



### Specifications

<b>Model</b>	<b>GP26</b>
<b>Item #</b>	<b>F-GP26</b>
<b>Pad Size</b>	<b>13"</b>
<b>Power Source</b>	<b>115-230V, 50/60 Hz</b>
<b>Motors (2)</b>	<b>1 HP, TEFC AC</b>
<b>Max Run Amperes</b>	<b>14.9</b>
<b>Gear Ratio / RPM</b>	<b>11:1 / 165</b>
<b>Power Cord</b>	<b>50 ft., (12-3) 2-piece industrial w/ twist lock</b>
<b>Weight (Total)</b>	<b>222 lbs.</b>
<b>Handle-Carriage</b>	<b>111 lbs</b>
<b>Head w/Motors</b>	<b>111 lbs.</b>
<b>Weights (2 sets)</b>	<b>44 lbs.</b>
<b>Solution Tank</b>	<b>6 Gallon</b>
<b>Solution Pump</b>	<b>60 PSI</b>

Specifications subject to change without notice

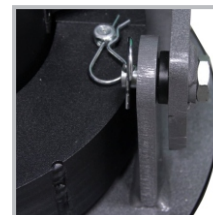

Carriage Mounts with Locking Pins for Easy Removal



Counter-Rotating Tools / Pad Drivers



Engineered to polish within 1/2" of walls



120 Lumen LED Lights (2 Sides, 2 Forward)



**GP26 Floor Machine Brushes & Pad Drivers - Dual Sets**



(2) 12" Stiff Nylon  
Dual Brush Set  
**A0037-Dual**



(2) 12" Stiff Grit  
Dual Brush Set  
**A0038-Dual**



(2)12" Stiff Poly  
Dual Brush Set  
**A0036-Dual**



(2)12" Polish  
Dual Brush Set  
**A0035-Dual**



(2) 12" Pad Driver  
Dual Set w/ Pad  
Centering Clamp  
**A0034-Dual**

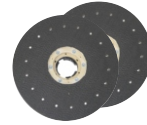

(2) 12" Diamond  
Dual Pad Set  
**CLAW15-Dual**





## Strip, Scrub, Polish



The HAWK WS30 dual motor floor machine is a high production, low fatigue machine for janitorial floor operators. Cover 30" per pass running two 15" brushes, pads or tools on a minimum 115V, 20 ampere circuit. This innovative design incorporates a special AC 115-230V, 50/60 Hz motor that works around the globe without requiring modifications.

Use for stripping, scrubbing and polishing every type hard floors. Engineered to work within 1/2" of walls. Operators can use the dual motor directional switch for navigating irregular surfaces with ease.

The two-piece design allows the handle-carriage to be easily separated from the dual motor head. This is advantageous when equipment needs transport in to hard-to-reach locations or those with restrictive access, such as basements or mezzanines.

Equipped with 6 gallon solution tank and electric pump for wet processes. Collar weights can be removed for lighter touch in polishing and transport.

### Engineered Design

- Dual AC-TEFC motors with 11:1 XHD gears
- Drives two counter-rotating 15" pad drivers gives a 30" scrub path
- 50 ft., (12-3) 2-piece industrial power cord with twist lock
- Control Center is front & center to the operator
- 3-position handle for transport, operation and storage
- 120 lumen LED lights (2- Sides, 2 Forward)
- 10"x2" grooved non-marking transport wheels
- Detachable handle-carriage for transport
- 6 Gallon solution tank with 60 PSI diaphragm pump
- Removable collar weights
- Built in dust control with combo 1.5" or 2" exhaust

### Safety

- Quiet 66 dB operation. Meets G42 requirements
- Built with UL listed components



Specifications	
Model	WS30
Item #	F-WS30
Pad Size	15"
Power Source	115-230V, 50/60 Hz
Motors (2)	1 HP, TEFC AC
Max Run Amp	14.9
Gear Ratio / RPM	11:1 / 165
Power Cord	50 ft., (12-3) 2-piece industrial w/ twist lock
Weight (Total)	264 lbs.
Handle-Carriage	132 lbs
Head w/Motors	132 lbs.
Optional Weights	22 lbs.
Solution Tank	6 Gallon
Solution Pump	60 PSI

Specifications subject to change without notice

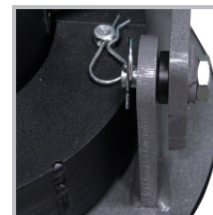

Carriage Mounts with Locking Pins for Easy Removal



Two Counter-Rotating Tools / Pad Drivers Run a 30" Scrub Path



Engineered to Work Within 1/2" of Walls



Handle Folds Up and Pin-Locks for Transport and Storage



**WS30 Rotary Floor Machine Brushes & Pad Drivers - Dual Sets**



(2) 15" Stiff Nylon  
Dual Brush Set  
**A0037-Dual**



(2) 15" Stiff Grit  
Dual Brush Set  
**A0038-Dual**



(2)15" Stiff Poly  
Dual Brush Set  
**A0036-Dual**



(2)15" Polish  
Dual Brush Set  
**A0035-Dual**



(2) 15" Pad Driver  
Dual Set w/ Pad  
Centering Clamp  
**A0034-Dual**

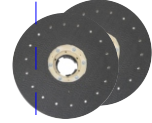

(2) 15" Diamond  
Dual Pad Set  
**CLAW15-Dual**



## Stripping, Scrubbing, Carpet Maintenance



Optional Cord Wrap

The HAWK Glide delivers up to twice the performance of traditional floor machines with greater safety and 1/3 less amp draw. The unique "Floating Head" WD™ Wheels Down handle carriage design provides 100% contact with the floor and steers the Glide in forward and backward movement - unlike the side-to-side movements of swing buffers. Use the Glide XHD model for the toughest jobs with 11:1 industrial gears to power tools and drivers at 165 RPM. Easy to learn. Easy to use.

### Power

- 1.5 HP, dual capacitor AC Motor
- 115-230V, 60 HZ (50 Hz optional)
- 50 ft., (14-3) 2-piece commercial power cord with cord lock
- **Glide** uses 10:1 helical-cut commercial gears to drives brushes, pads and tools at 175 RPM
- **Glide XHD** (Extra Heavy Duty) uses triple-planetary XHD 11:1 helical-cut industrial gears, case hardened with steel coupler drives brushes, pads and tools at 165 RPM.

### Engineered Design

- Exclusive "Floating Head" wheels down detachable handle carriage design produces 100% flat contact with the floor
- All steel construction with welded frame. Heavy-duty powder-coated steel handle with 4-position pin lock.
- 17" and 20" steel brush covers with full wraparound bumper
- Dual steel operating triggers. Thumb-operated safety switch.
- Comfortable vinyl-dipped foam handle grips
- 2" x 6" non-marking ball bearing wheels
- Glide Deluxe model (#F91-17-DX, #F91-20-DX) adds the 4 Gallon solution tank, premium pad driver and splash guard
- Optional splash guard (#SPLASH17-WD-17", #SPLASH20-WD-20") and dust collection kit (#HP0031-DC17 #HP0031-DC20)
- Optional 4 gallon solution tank (#A0001-Color4) 7 colors

### Safety Features

- Quiet 66 dB operation. Meets GS42 standard.
- Built with UL listed components



## Specifications

Model	Glide 17	Glide 17XHD	Glide 20	Glide 20XHD
Item #	F91-17-01	F92-17-01	F91-20-01	F92-20-01
Machine Size	17"	17"	20"	20"
Pad Size	16"	16"	19"	19"
Motor Cover	Powder-Coated	Chrome	Powder-Coated	Chrome
Drive Gears	10:1	11:1	10:1	11:1
Pad Speed	175 RPM	165 RPM	175 RPM	165 RPM
Amp Draw	6.7	7.1	6.9	7.3
Weight Lbs.	113	113	115	115
dB Rating	66 dB	69 dB	66 dB	69 dB

## All Models

Motor	1.5 HP, 66 frame dual capacitor AC
Power Source	115V, 60Hz power. (230V Optional)
Power Cord	50 ft., 2-piece (14-3) industrial with cord lock

Subject to Change Without Notice



Optional 4 Gallon Solution Tank



Optional Dust Control Ring Connects to Tank



Optional Osprey Sprayer Kit

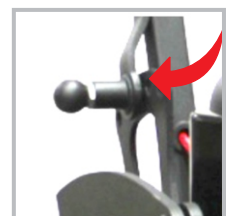

4 Position Pin Lock Handle All Steel Construction





## Stripping, Scrubbing, Carpet Maintenance

The HAWK Glide 2-Speed machines deliver up to twice the performance of traditional floor machines. The unique "Floating Head" WD™ Wheels Down handle carriage design provides 100% contact with the floor and steers the Glide in forward and backward movement - unlike the side-to-side movements of swing-buffers. The 2-speed motor scrubs at 165 RPM (Glide) or 175 RPM (XHD).

### Power

- 1.5 HP, dual capacitor AC motor
- 115V, 50/60 Hz power
- 50 ft., 2-piece (14-3) commercial power cord with cord lock
- Hi/Low speed switch is located on the motor
- **Glide 2-Speed** uses triple-planetary HD 10:1 helical-cut commercial gears to drives brushes and pads at 175 / 320 RPM
- **Glide 2-Speed XHD** (Extra Heavy-Duty) uses triple-planetary XHD 11:1 helical-cut industrial gears, case hardened with steel coupler. Drives brushes and pads at 165 / 300 RPM

### Engineered Design

- 17" and 20" steel brush covers with full wraparound bumper
- All steel construction with welded frame. Heavy-duty powder-coated detachable steel handle with 4-position pin lock. Exclusive WD™ Wheels Down handle design
- Dual steel operating triggers. Thumb-operated safety switch
- Comfortable vinyl-dipped foam handle grips
- 2" x 6" non-marking ball bearing wheels
- **Glide 2-Speed Deluxe** models add the 4 gallon solution tank, premium pad driver and splash guard
- Optional splash guard (**#SPLASH17-WD** -17", **#SPLASH20-WD** - 20") and dust collection kit (**#HP0031-DC17** **#HP0031-DC20**)
- Optional 4 gallon solution tank (**#A0001-Color4**)
- Optional Osprey sprayer kit

### Safety Features

- Quiet 66 dB operation. Meets GS42 standard.
- Built with UL approved components



### Specifications

Model	GLIDE 17-2S	GLIDE 17-2SXHD	GLIDE 20-2S	GLIDE 20-2SXHD
Item#	F93-17	F93-17	F94-17	F0091-20
Drive Gears	10:1	11:1	10:1	11:1
Machine Size	17"	17"	20"	20"
Pad Size	16"	16"	19"	19"
Speed RPM	175 / 320	165 / 300	175 / 320	165 / 300
Amp Draw	8.5 / 9.1	8.5 / 9.1	9.2 / 9.6	9.2 / 9.6
Weight	113 lbs.	113 lbs.	115 lbs.	115 lbs.

### All Models

Motor	1.5 HP 2-speed rectified DC motor
Power	115V, 50/60 Hz (230V Optional)
Power Cord	50 ft., (14-3) 2-piece commercial with cord lock
Sound Level	62 dB (low speed) - 69 dB (high speed) - Meets GS42 Std.

Subject to Change Without Notice



Optional 4 Gallon Solution Tank



Optional Dust Control Ring Connects to Tank



Optional Osprey Sprayer Kit



5-Position Pin Lock Handle All Steel Construction



## Glide Sanding with Active Dust Control



Includes  
40# Weight Kit

The HAWK Glide Sanding Star makes wood floor maintenance faster and easier. Designed to be nimble for scuffing, blending and sanding on all types of finished wood, bare wood and VCT.

We combine the Glide "Floating-Head" Wheel's Down frame design with the Mighty 1.0 HP AC motor, and mount our six quart, triple-filter vacuum on the powder-coated steel handle carriage. The Glide Sanding Star uses XHD 11:1 industrial gears to spin floor sanding drivers at 165 RPM. A twist lock securely connects the machine to its 50 ft. (12-3) industrial power cord.

The Glide Sanding Star uses a HAWK 360 Dust Pickup System™ to collect airborne dust and debris internally at the floor level with its proprietary 360 degree duct system. Floor preparation debris control is made safe and simple.

### Power

- Powerful 1.0 HP TEFC AC motor
- 115-230V, 50/60 Hz AC power - World Motor
- 50 ft., (12-3) 2-piece industrial power cord with twist lock
- XHD 11:1 helical-cut case hardened gears with steel coupler spins sanding drivers at 165 RPM

### Engineered Design

- Exclusive WD™ detachable handle-carriage design with 5-position pin-set handle lock
- HAWK 360 Dust Pickup System™ makes sanding "dust free"
- Includes handle-mounted, 6 quart dual-stage tank vacuum with triple filtration
- 2" x 8" non-marking ball bearing wheels
- Welded powder-coated handle with vinyl-dipped foam grips
- Dual steel operating triggers with negative pressure on/off switch
- Includes (4) 10 lb. weights and 360 degree dust skirt
- Optional drivers, brushes and pads

### Safety Features

- Built with UL listed components



Specifications				
Model	Sanding Star 17"	Sanding Star 17" w/ Vac.	Sanding Star 20"	Sanding Star 20" w/Vac.
Item #	F95-17-01	F95-17-01S	F95-20-01	F95-20-01S
Machine Size	17"	17"	20"	20"
Pad Size	16"	16"	19"	19"
Pad Speed	165 RPM	165 RPM	165 RPM	165 RPM
Gear Box	11:1	11:1	11:1	11:1
Amp Draw	6.7	6.7	7.1	7.1
Weight	137 lbs.	147 lbs.	139 lbs.	149 lbs.
All Models				
Motor	1.0 HP, 56 frame TEFC dual capacitor AC			
Power	115V, 50/60 Hz power. (230V optional)			
Power Cord	50 ft., (12-3) 2-piece industrial with twist lock			
Sound Level (ave.)	66 dB Meets GS42 standard			



360 Degree Duct Cover  
Directs Debris to  
Vacuum Port



Includes Handle  
Mounted 6 Quart Tank  
Vacuum



5 Position Pin  
Lock Handle



50 ft. Power Cord  
with Twist Lock

Subject to Change Without Notice



### Stripping, Scrubbing, Resurfacing

Merlin floor machines are built for high productivity in harsh environments like concrete resurfacing and natural stone polishing. The unique "Floating Head" WD Wheels Down design provides 100% contact with the floor and perfect operator control.

Easier operation and faster production times are what sets this unit apart from standard rotary designs. Heavier work with less energy. Breaks down into multiple pieces for moving by a single person.

The 100% steel construction is accented with two exteriors

- **Merlin TE** - Black powder coated motor & brush cover
- **Merlin TECP** - Chrome motor with powder-coated brush cover
- **Merlin DX Option** - Adds pad driver, splash guard and 4-gallon solution tank

#### Power

- 1.5 HP, 180 frame TEFC dual capacitor AC motor
- 115-230V, 60 Hz power (50 Hz optional)
- 50 ft., (12-3) 2-piece industrial power cord with twist lock
- Triple-planetary XHD 11:1 helical-cut industrial gears drive pads, brushes, diamond tools, Scraper, Claw and Orbitec at 165 RPM

#### Engineered Design

- Handle disassembles in 60 seconds. Easy transport and storage
- All steel construction with welded "Floating Head" frame
- Heavy-duty powder-coated steel handle with 5-position pin lock
- The heavy duty motor guard protects from impact damage
- Thumb-operated safety switch
- Dual steel operating triggers
- Negative pressure on/off switch
- 2" x 8" non-marking load bearing, ball bearing wheels
- Includes 80 lb. weight kit
- Optional 28 lb. carriage weight kit
- Optional 4 gallon solution tank (#A0001-Color4)
- Optional 6 gallon solution tank (#SME-2QRBLK)

#### Safety Features

- Quiet 66 dB operation. Meets GS42 standard.
- UL/CUL listed



### Specifications

<b>Model</b>	<b>Merlin 17 TE</b>	<b>Merlin 20 TE</b>
<b>Item #</b>	F70-17-01-B	F70-20-01-B
<b>Motor / Cover</b>	Black Powder Coated Motor & Brush Cover	Black Powder Coated Motor & Brush Cover
<b>Model</b>	<b>Merlin 17 TECP</b>	<b>Merlin 20 TECP</b>
<b>Item #</b>	F70-17-01-C	F70-20-01-C
<b>Motor / Cover</b>	Chrome Motor & Black Powder Coated Frame	Chrome Motor & Black Powder Coated Frame
<b>Machine Size</b>	17"	20"
<b>Pad Speed</b>	165 RPM	165 RPM
<b>Amp Draw</b>	7.9	8.5

### All Sizes

<b>Motor</b>	1.5 HP, 180 frame, TEFC dual capacitor AC
<b>Power</b>	115-230V, 60Hz (50 Hz optional)
<b>Power Cord</b>	50 ft., (12-3) 2-piece industrial with twist lock
<b>Drive Gears</b>	Triple-planetary XHD 11:1 helical-cut industrial
<b>Sound Level (ave.)</b>	66 dB - Meets GS42 standard

Subject to Change Without Notice



Two Piece Twist Lock Connects Machine to 50 ft. Power Cord



Optional Carriage Weight Kit (28. lbs.)



5-Position Pin Lock Handle All Steel Construction





### Stripping, Scrubbing, Restoration



Includes 80# Weight Kit

Merlin 2-Speed takes advantage of innovative engineering and modern design to set new records in production and user safety.

The unique "Floating Head" WD™ Wheels Down handle carriage design provides 100% contact with the floor and steers the Merlin in forward and backward movement - unlike the side-to-side movements of swing buffers.

The Merlin 2-Speed draws 1/3 less amps than standard machines. Strip and scrub floors at 165 RPM. Buff and polish at 320 RPM. Power to drive diamond tools, Claw, Scraper and Orbitec tools.

#### Power

- 1.5 HP 2-speed rectified DC motor
- Hi-Lo 2-speed toggle switch mounted on side of motor
- 115V, 50/60 Hz power (230V optional)
- 50 ft., (12-3) 2-piece industrial power cord with cord lock

#### Drive System

- Triple planetary XHD 11:1 helical cut industrial gears, drives brushes and tools at 165 RPM or 300 RPM

#### Engineered Design

- WD™ Wheels Down, 5 position pin-lock handle disassembles in 60 seconds for transport and storage
- All steel construction with welded powder-coated frame
- 17" and 20" brush covers with 360 degree wrap-around bumper
- Thumb-operated safety switch. Negative pressure on/off switch
- Dual steel operating triggers
- 2" x 8" non-marking load bearing, ball bearing wheels
- Includes 80# weight kit
- Optional dust pickup kit - 17" and 20"
- Optional 4 gallon solution tank (#A0001-Color4)
- Optional 6 gallon solution tank kit (#SME-2QRBLK) includes solution tank, diamond pad driver and splash guard

#### Safety Features

- Quiet operation – 62 dB (low speed) 69 dB (high speed). Meets GS42 requirements.
- Built with UL / CUL listed components



### Specifications

Model #	Merlin 2-Speed 17	Merlin 2-Speed 20
Item #	F71-17-01	F71-20-01
Pad Size	16 inch	19 inch
Brush / Tool Size	15 inch	18 inch
Pad Speed	165 / 300 RPM	165 / 300 RPM
Amp Draw	8.5 / 9.1	9.2 / 9.6
All Sizes		
Motor	1.5 HP, 2-speed rectified DC	
Power	115V, 50/60 Hz. (230V optional)	
Drive Gears	Triple planetary XHD 11:1 helical cut industrial gears	
Power Cord	50 ft., (12-3) 2-piece industrial with cord lock	
Sound Level (ave.)	Quiet 62 dB (165 rpm) 69 dB (300 rpm) operation Meets GS42 Specs	

Subject to Change Without Notice



5 Pin Handle Lock All Steel Construction



Power to Drive HAWK Grinder and Scraper



80 lb. Weights Mounts on Apron with Locking Pins



Includes  
80# Weight Kit

## Stripping, Sanding, Resurfacing &

The HAWK Merlin 360™ combines the “Floating Head” WD™ Wheels Down engineering design with the proprietary Hawk 360™ dust pick up system.

The 360 Dust Pick Up System collects airborne dusts and debris in the brush cover with its proprietary 360 degree duct system. A 2” top-mounted dust port connects to all commercial tank vacuums with 1.5” or 2” hose. Cutting, polishing and floor sanding debris control is now safe and simple.

The Merlin 360 is built for high productivity in harsh environments like concrete resurfacing and natural stone polishing. It is powered by a 180 frame TEFC (Totally Enclosed Fan Cooled) dual capacitor AC motor with a severe-duty, helical-cut 11:1 gear drive.

### Power

- 1.5 HP, 180 frame TEFC dual capacitor AC Motor
- Black or chrome motor cover. Includes motor impact protection plate.
- 115-230V, 60 Hz (50 Hz optional)
- 50 ft., (12-3) 2-piece industrial power cord with twist lock
- Extra heavy-duty steel helical-cut 11:1 gear drive with steel coupler

### Engineering Design

- Built with HAWK 360 dust pick up brush cover and with wraparound dust guard.
- Floating-Head WD™ Wheels-Down steel handle has 5 position pin-lock
- Powerful motor drives scrapers, diamond tools and sanding tools
- The heavy-duty motor guard protects the motor from impact damage
- Foot operated Lift Assist lever for easy transport
- Dual steel operating triggers with negative pressure on/off switch
- Thumb-operated safety switch with comfort cushion grips
- 2” x 8” non-marking load bearing ball bearing wheels
- Includes removable weight set w/ (4) 20 lb. weights and locking pins
- Optional (2) 25 lb. carriage weight kit (#HPA0032-1)

### Safety Features

- Built in dust collection
- Quiet 66 dB meets GS42 standard
- Build with UL/CUL listed components



## Specifications

<b>Model</b>	<b>Merlin 360-17 Black</b>	<b>Merlin 360-20 Black</b>
<b>Item #</b>	F75-17B	F75-20B
<b>Model</b>	<b>Merlin 360-17 Chrome</b>	<b>Merlin 360-20 Chrome</b>
<b>Item #</b>	F75-17C	F75-20C
<b>Machine Size</b>	17”	20”
<b>Pad Size</b>	16”	19”
<b>Pad Speed</b>	165 RPM	165 RPM
<b>Amp Draw</b>	7.9	8.5
<b>Weight</b>	233 lbs.	235 lbs.

## All Sizes

<b>Motor</b>	1.5 HP, 180 frame, TEFC dual capacitor AC
<b>Power</b>	115-230V, 60Hz (50 Hz optional)
<b>Power Cord</b>	50 ft., (12-3) 2-piece industrial with twist lock
<b>Drive System</b>	Triple-planetary XHD 11:1 helical-cut industrial gears
<b>Sound Level (ave.)</b>	66 dB - Meets GS42 standard

Subject to Change Without Notice



Carriage Weight Set fits Merlin and Merlin 360



5 Handle Heights with Pin-Lock



Brush Shroud is Built with 2” Vacuum Port



360 Degree Duct in Brush Apron Directs Debris to Vacuum Port



## Dry Stripping, Scrubbing, Stripping



The HAWK G2 Raptor has a 20 inch wide rectangular head and is easy to maneuver with less vibration and operator fatigue than other orbiting brands. The G2 Raptor easily reaches into corners and along baseboards.

The HAWK G2 Raptor strips floor finish without chemicals. It is excellent for sanding, scrubbing and stone polishing. Use wet or dry. Easy to learn. Easy to use.

### Power

- 1.5 HP, 180 frame, TEFC dual capacitor AC motor
- 115-230V, 60 Hz power
- 50 ft., (12-3) 2-piece industrial power cord with cord lock
- Eccentric balanced design drives pads at 10 times the speed of a rotary machine

### Engineered Design

- 4 primary industrial vibration isolators
- Heavy-duty steel handle with adjustable handle lock
- Thumb-operated safety switch. Dual steel operating triggers.
- Comfortable vinyl-dipped foam handle grip
- 2" x 8" non-marking ball bearing wheels
- Optional Active Vacuum Kit with 6 quart tank vacuum, dust skirt, vacuum hoses and hardware (#TH1011-RAP)
- Optional tool kit for connection to your own vacuum includes skirt and barb vacuum fitting
- Optional 2.5 gallon handle mount solution tank (#A001-RAPBLK 2.5)
- Optional orbital scrub brush 20" x 14" (#A0076-2014)

### Safety Features

- Quiet 60 dB operation. Meets GS42 standard
- UL/CUL listed



## Specifications

<b>Model</b>	HAWK G2 Raptor
<b>Item #</b>	F98-RAP
<b>Pad Size</b>	20" x 14"
<b>Pad Speed</b>	1740 RPM
<b>Power Source</b>	115-230V, 60 Hz power
<b>Motor</b>	1.5 HP, 180 frame, TEFC dual capacitor AC
<b>Amp Draw</b>	9.0
<b>Power Cord</b>	50 ft., (12-3) 2-piece industrial with cord lock
<b>Drive System</b>	Eccentric balanced orbital drive
<b>Vibration Isolators</b>	4 primary industrial
<b>Weight</b>	194 lbs. (0.657 lbs/in <sup>2</sup> )
<b>Sound Level (ave.)</b>	66 dB - Meets GS42 standard

Subject to Change Without Notice

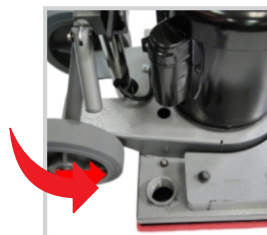

Milled Dust Control Connector



Optional Active Vacuum Kit

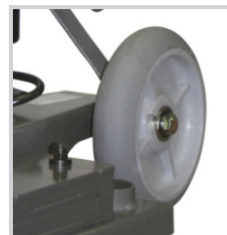

8" Wheels for Easy Transport

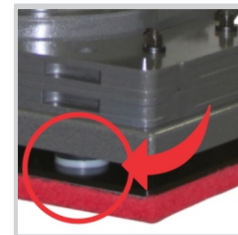

Industrial 2" Vibration Isolators





### Dry Stripping, Scrubbing,

The TigerHawk 1410 revolutionary rectangular "Floating Head" machine is easy to maneuver, with less vibration and less operator fatigue than other orbiting brands. The WD™ Wheels-Down handle design assures 100% pad contact with the floor.

The 1410 works three times faster than rotary floor machines, easily reaching into corners and along baseboards. Add the optional 2.5 gallon solution tank for even greater productivity.

The TigerHawk 1410 can strip large areas of floor finish without chemicals and is excellent for sanding, scrubbing and stone polishing. Easy to learn. Easy to use.

#### Power

- 0.5 HP, TEFC AC Motor, 115-230V, 50/60 HZ
- 50 ft. (14-3) 2-piece commercial with cord lock

#### Drive System

- Eccentric balanced orbital drive works at 10 times the speed of a rotary floor machine

#### Engineered Design

- Dual vibration isolation system
- Heavy-duty powder-coated steel handle with 5-position pin lock
- Built with vacuum port. Order vacuum equipment separately
- Thumb-operated safety switch
- Dual steel operating triggers. Negative pressure on/off switch
- 1" x 5" non-marking ball bearing wheels
- Optional dust skirt and vacuum assembly kit (#TH1011-1410)
- Optional cord wrap hook
- Optional Osprey Sprayer Kit (#TH1010-MTY) and 2.5 gallon Solution Tank (#A0001-RAPBLK2.5) for even greater productivity

#### Safety Features

- Quiet 66 dB operation. Meets GS42 standard.
- Built with UL approved components



Optional  
Cord Wrap  
Hook



### Specifications

<b>Model</b>	<b>TigerHawk 1410</b>
<b>Item #</b>	F98-TH-1410
<b>Pad Size</b>	14" x 10"
<b>Pad Speed</b>	1725 RPM
<b>Motor</b>	0.5 HP, 56 frame, TEFC single capacitor AC
<b>Power Source</b>	115-230V, 50/60 Hz
<b>Power Cord</b>	50 ft., (14-3) 2-piece commercial with cord lock
<b>Amp Draw</b>	8.3
<b>Drive System</b>	Eccentric balanced orbital drive
<b>Vibration Isolators</b>	4 primary / 2 secondary industrial
<b>Weight lbs.</b>	107
<b>Down Pressure</b>	0.57 lbs./sq. in.
<b>Sound Level (ave.)</b>	66 dB - Meets GS42 standard

Subject to Change Without Notice



Floating Head Frame  
with 1.5" Vacuum Port



Optional Full  
Wraparound Dust Skirt  
#TH1011-1410

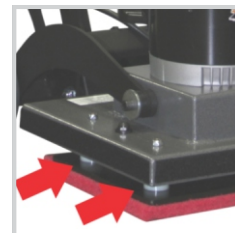

(4) Rubber Vibration  
Isolators

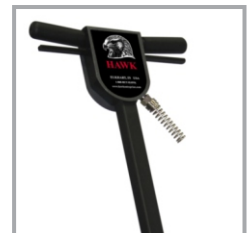

Welded Powder-  
Coated  
Steel Construction



## Dry Stripping, Scrubbing, Stripping

The TigerHawk 2014 and 2814 with revolutionary WD™ Wheels Down floating head technology are the most productive orbitals on the market. With over 0.79 pounds per square inch of pressure moving at over 1740 RPM, you power through finish removal without chemicals. Scrub, strip, or sand floors effortlessly with less noise and fatigue.

Our large 1.5 HP, 180 frame TEFC (Totally Enclosed Fan Cooled) motor is connected to a solid steel drive plate and balanced via easy access eccentric driver. Over 14 vibration isolators, combined with HAWK exclusive handle-carriage mounting system eliminates vibration to the operator. The handle removes easily without tools for transport and storage. Includes 4 caster steel transport dolly and drip tray.

### Power

- 1.5 HP, 180 frame, TEFC dual capacitor AC motor
- 115-230V, 60 Hz power
- 50 ft., (12-3) 2-piece industrial power cord with twist lock
- Eccentric balanced design drives pads at 1740 RPM

### Engineered Design

- Dual vibration isolation system with 6 (2014) or 8 (2814) industrial isolators
- Heavy-duty powder-coated steel handle with 5-position pin lock
- The WD™ handle is easy to remove for transport and storage
- The heavy-duty motor guard protects the motor from impact damage
- Thumb-operated safety switch. Dual steel operating triggers
- Comfortable vinyl-dipped foam handle grip
- 2" x 8" non-marking ball bearing wheels
- Includes transport cart and drip tray
- Optional Active Vacuum Kit with 6 quart tank vacuum, dust skirt, vacuum hoses and hardware (#TH1011)
- Optional Osprey Sprayer System includes motor-mounted sprayer pump, 4-gallon solution tank and hardware (#TH1010)

### Safety Features

- Quiet 60 dB operation. Meets GS42 standard.
- UL/CUL listed



### Specifications

Model	TigerHawk 2014	TigerHawk 2814
Item #	F98-TH2014	F98-TH2814
Pad Size	20" x 14"	28" x 14"
Pad Speed	1740 RPM	1740 RPM
Amp Draw	7.1 Amp	7.8 Amp
Weight	250 lbs.	305 lbs.
Pad Pressure	0.89 lbs/in <sup>2</sup>	0.79 lbs/in <sup>2</sup>
Vibration Isolators	6 Primary / 8 Secondary	8 Primary / 8 Secondary

### All Models

Motor	1.5 HP, 180 frame, TEFC dual capacitor AC
Power Source	115-230V, 60 Hz power
Power Cord	50 ft., (12-3) 2-piece industrial with twist lock
Drive System	Eccentric balanced orbital drive
Sound Level (ave.)	60 dB - Meets GS42 standard

Subject to Change Without Notice



Steel Frame with Rear Vacuum Port



Works Along Baseboards



Two-Piece Twist Lock Connects Machine to 50 ft. Power Cord



Includes Transport Cart and Drip Tray



## Surface Preparation, Scrubbing,

The HAWK RedTail 2014-180 is great for surface preparation and cleaning any hard surface. The unique "Floating Head" WD™ Wheels Down handle carriage design provides 100% contact with the floor for perfect operator control. The handle is easily removed for transport and storage.

The 180 frame HD motor, severe-duty helical-cut gears and 1740 RPM orbital pad speed, makes the RedTail ideal for the harshest jobs. Use wet or dry.

### Power

- 1.5 HP, 180 frame, TEFC dual capacitor AC motor
- 115-230V, 60 Hz power
- 50 ft., (12-3) 2-piece industrial power cord with cord lock

### Drive System

- Eccentric balanced orbital drive works at 1740 RPM

### Engineering Design

- Dual vibration isolation system with 6 industrial isolators
- The exclusive orbital technology reduces vibration and makes scrubbing easier with less operator fatigue
- "Floating Head" WD™ Wheels Down welded steel frame
- Heavy-duty, powder-coated steel handle with 5-position pin lock
- Comfortable operation with vinyl-dipped foam handle grips
- Thumb operated safety switch. Dual steel operating triggers
- Negative pressure on/off switch
- 2" x 6" non-marking ball bearing wheels
- Optional Active Dust Control Kit includes 6 quart tank vacuum, dust skirt and hardware (#TH1011-RAP)
- Optional 4 gallon solution tank (#A0001-Color4)

### Safety Features

- Quiet 66 dB operation. Meets GS42 standard.
- Built with UL approved components



## Specifications

<b>Model</b>	<b>HAWK RedTail 2014-180</b>
<b>Item #</b>	F98-RT180
<b>Pad Size</b>	20" x 14"
<b>Pad Speed</b>	1740 RPM
<b>Motor</b>	1.5 HP, 180 frame, TEFC Dual Capacitor AC
<b>Power Source</b>	115-230V, 60 Hz power
<b>Amp Draw</b>	7.1 Amp
<b>Power Cord</b>	50 ft., (12-3) 2-piece industrial with cord lock
<b>Weight</b>	171 lbs.
<b>Pad Pressure</b>	0.61 lbs/in <sup>2</sup>
<b>Drive System</b>	Eccentric balanced orbital drive
<b>Vibration Isolator</b>	(6) primary, (6) secondary industrial
<b>Sound Level (ave.)</b>	66dB - Meets GS42 standard

Subject to Change Without Notice



Orbiting Pads and WD™ Handle - Works in Tight Spaces



Disassembles Without Tools for Easy Transport & Storage

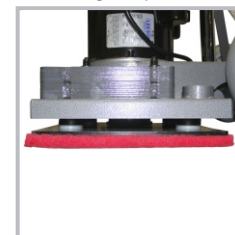

Unique Vibration Damping Design



Optional Dust Control Kit #TH1011-RT





## Burnishing & Refinishing

The HAWK High Speed is known for its balance, durability and value. HAWK offers the largest selection of burnishers in four sizes; 13", 15", 17" and 20" and three speeds; 1500, 1800 or 2000 RPM.

The 17" and 20" Active Dust Control DC models include a dust ring and filter; the perfect addition to any Green Cleaning program.

### Power

- 1.5 HP, 66 frame, DC rectified motor
- 115V, 50/60 Hz power (230V optional)
- 50 ft., (14-3) 2-piece industrial power cord with cord lock
- Multi V-Belt drives pads at 1500, 1800 and 2000 RPM

### Engineering Design

- Welded steel frame. One piece chromed heavy duty steel handle with variable position positive lock
- 13", 15", 17" and 20" steel brush covers w/full wraparound bumper
- 17" and 20" Dust Control models include a dust ring and filter
- Thumb operated safety switch
- Negative pressure on/off switch
- Dual steel operating triggers
- Comfortable vinyl-dipped foam grip handle
- 1" x 5" non-marking ball-bearing wheels
- Includes flexible pad holder with pad centering clamp

### Safety Features

- Quiet operation - 69 dB (Standard), 62 dB (Dust Control). Meets GS42 standard
- UL/CUL listed (1500 RPM models)
- Built with UL listed components



## Specifications

Machine Pad Size	13" Standard	15" Standard	17" Standard	17" Dust Control	20" Standard	20" Dust Control
	13"	15"	17"	16"	20"	19"
<b>Model Item #</b>	<b>F1500-13</b>	<b>F1500-15</b>	<b>F1500-17</b>	<b>F1500-17DC</b>	<b>F1500-20</b>	<b>F1500-20DC</b>
<b>Amp Draw</b>	9.1	9.6	13.0	12.2	13.8	13.1
<b>Model Item #</b>	<b>F1800-13</b>	<b>F1800-15</b>	<b>F1800-17</b>	<b>F1800-17DC</b>	<b>F1800-20</b>	<b>F1800-20DC</b>
<b>Amp Draw</b>	9.5	9.9	13.9	13.2	14.6	13.6
<b>Model Item #</b>	<b>F2000-13</b>	<b>F2000-15</b>	<b>F2000-17</b>	<b>F2000-17DC</b>	<b>F2000-20</b>	<b>F2000-20DC</b>
<b>Amp Draw</b>	10.0	10.8	14.9	13.9	16.4	14.8
<b>Sound Level (all)</b>	69 dB	69 dB	69 dB	62 dB	69 dB	62 dB
<b>Weight (all)</b>	84 lbs.	86 lbs.	88 lbs.	90 lbs.	90 lbs.	92 lb

## All Models

<b>Motor</b>	1.5 HP, 66 frame DC rectified motor
<b>Power Source</b>	115V, 50/60 Hz (230V optional)
<b>Power Cord</b>	50 ft., (14-3) 2-piece commercial with cord lock
<b>Belt Drive</b>	Multi-V belt drive

Subject to Change Without Notice



## Burnishing & Refinishing



The Hawk High-Speed Burnisher with AC motor is a balanced force of polishing power. These models are built with a durable 1.5 HP, 56 frame TEFC motor that requires little maintenance, use less power than DC motors, are less effected by heavy hands in operation and runs cleaner than traditional DC motor. The motor shroud protects the inner workings from dust and moisture.

AC motors are often the better choice for use in buildings with older circuitry and with less experienced users. AC motors use less energy than DC and are not as effected by heavy hands in operation, preventing trips on the circuit breakers. AC burnishers spinning at 1250 RPM are equivalent to a DC motors classified as 1500 RPM when its pad is in contact with the floor. Unlike DC motors, AC motor machine do not slow with added burnisher load.

The AC model is the perfect addition to any Green Cleaning program.

### Power

- 1.5 HP, TEFC dual capacitor AC motor
- 115-230V, 60 Hz power
- 50 ft., (14-3) 2-piece commercial power cord with cord lock
- Multi V-Belt drives pads at 1000 RPM

### Engineering Design

- 13", 15", 17" and 20" standard models are built with powder coated steel brush cover with full wraparound bumper
- 17" and 20" Dust Control models add a dust ring and filter
- Welded steel frame
- One-piece chrome handle with variable position positive handle lock
- Comfortable vinyl-dipped foam handle grips
- Thumb-operated safety switch. Negative pressure on/off switch
- Dual steel operating triggers
- 1" x 5" non-marking wheels
- Includes flexible pad holder with pad centering clamp

### Safety Features

- Quiet operation - 58 dB (Standard), 53 dB (Dust Control). Meets GS42 standard.
- Built with UL listed components



## Specifications

	13" Standard	15" Standard	17" Standard	17" w/Dust Control	20" Standard	20" w/Dust Control
Pad Size	13"	15"	17"	16"	20"	19"
Model	High Speed 1000 w/AC Motor					
Item #	F1000-13TE	F1000-15TE	F1000-17TE	F1000-20TE	F1000-17TE	F1000-20TEDC
Amp Draw	10.0	11.2	12.4	11.6	13.5	12.4
<b>All Models</b>						
Motor	1.5 HP, 56 frame TEFC AC motor					
Power	115V, 50/60 Hz power. 230V available.					
Power Cord	50 ft., (14-3) 2-piece commercial with cord lock					
Belt Drive	Multi-V Belt Drive					
Sound Level (ave.)	58 dB	58 dB	58 dB	53 dB	58 dB	53dB
Machine Weight	84 lbs.	86 lbs.	88 lbs.	88 lbs.	90 lbs.	90 lbs.

Subject to Change Without Notice



## Burnishing & Refinishing



The HAWK Centerfold High-Speed Burnisher with DC motor is renowned for its balance, durability and value. The non-locking handle allows the head to keep constant pad pressure assuring a steady amp draw and consistent floor shine. The fold-up handle is designed for easy transport and for storage in tight spaces.

Available in 4 sizes and 3 speeds. The 17" and 20" Active Dust Control models include a dust ring and filter. A Centerfold is the perfect addition to every Green Cleaning program.

### Power

- 1.5 HP, DC rectified motor
- 115V, 60 Hz power. (230V optional).
- 50 ft., (14-3) 2-piece commercial power cord with cord lock

### Drive System

- Multi V-Belt drives pads at 1500, 1800 or 2000 RPM

### Engineered Design

- Built with welded, heavy gauge industrial powder coated steel
- Variable position handle with vinyl grips
- 13", 15", 17" and 20" brush cover w/ full wraparound bumper
- Thumb operated safety switch
- Negative pressure on/off switch
- Dual steel operating triggers
- 1" x 5" non-marking ball bearing wheels
- Includes flexible pad holder with pad centering clamp

### Safety Features

- Quiet operation - 69 dB (Standard), 62 dB (Dust Control). Meets GS42 standard
- UL/CUL listed



## Specifications

Machine	13" Standard	15" Standard	17" Standard	17" Dust Control	20" Standard	20" Dust Control
<b>1500 RPM</b>						
Model	HCF1513-1500	HCF1515-1500	HCF1517-1500	HCF1517-1500DC	HCF1520-1520	HCF1520-1520DC
Item #	F1500-13CF	F1500-15CF	F1500-17CF	F1500-17CFDC	F1500-20CF	F1500-20CFDC
Amp Draw	11.4	11.9	12.6	9.8	13.2	10.2
<b>1800 RPM</b>						
Model	HCF1513-1800	HCF1515-1800	HCF1517-1800	HCF1517-1800DC	HCF1520-1800	HCF1520-1800DC
Item #	F1800-13CF	F1800-15CF	F1800-17CF	F1800-17CFDC	F1800-20CF	F1800-20CFDC
Amp Draw	11.7	12.3	13.2 10.1	13.9	10.7	
<b>2000 RPM</b>						
Model	HCF1513-2000	HCF1515-2000	HCF1520-2000	HCF1520-2000DC	HCF1517-2000	HCF1517-2000DC
Item #	F2000-13CF	F2000-15CF	F2000-17CF	F2000-17CFDC	F2000-20CF	F2000-20CFDC
Amp Draw	11.8	12.4	13.8	11.1	14.8	11.8
<b>All Models</b>						
Motor	1.5 HP, DC rectified motor					
Power	115V, 60 Hz power (230 Available)					
Power Cord	50 ft., (14-3) 2-piece commercial with cord lock					
Belt Drive	Multi-V belt drive					
Sound Level	69 dB	69 dB	69 dB	62 dB	69 dB	62 dB
Weight	84 lbs.	86 lbs.	88 lbs.	90 lbs.	90 lbs.	92 lbs.

Subject to Change Without Notice





## Stripping, Scrubbing, Buffing

The BlackHawk has been redesigned for easy transport in today's smaller vehicles. The exclusive Pin-Set™ Handle Lock does away with nuisance adjustments that are common with friction handle locks. Steel construction with commercial-quality components include ball bearing wheels, commercial grade cord and grips, a solid steel handle lock and the durable 1.5 HP dual-capacitor motor. The BlackHawk buffer can deliver 24/7 reliable results for years to come.



Shown  
With Optional  
Power Cord  
Wrap  
(#KIT3001-1BLK)

### Power

- 1.5 HP dual capacitor AC motor
- 115V, 60 Hz (50 Hz optional) power
- 50 ft., (14-3) 2-piece commercial power cord with cord lock

### Drive System

- **BlackHawk** uses triple-planetary HD 10:1 helical-cut commercial gears. Drives brushes and pads at 175 RPM
- **BlackHawk XHD** (Extra Heavy Duty) planetary 11:1 helical-cut industrial gears, case hardened with steel coupler. Drives brushes and pads at 165 RPM

### Engineered Design

- The all steel 2-piece unit detachable handle with pin-set handle lock disassembles in 60 seconds, no tools required
- Quality welded steel construction
- Pin Set™ Handle Lock adjusts the handle to 4 heights
- 17" or 20" brush covers with 360 degree gray wraparound bumpers
- Thumb-operated safety switch. Dual steel operating trigger
- Negative pressure on/off switch
- Sturdy 1" x 5" non-marking ball bearing wheels
- Includes Tufted Bristled Pad Driver (#A0010-4 - 17") or (#A0011-3- 20")
- Optional 4 gallon solution tank (#A0001-NAT4)
- Optional Splash Guard (#SPLASH17) or (#SPLASH20)
- Optional handle mounted power cord wrap (#KIT3009-1BLK)

### Safety Features

- Quiet 62 dB operation. Meets GS42 standard
- Built with UL listed components



## Specifications

Model	BlackHawk 17	BlackHawk XHD 17	BlackHawk 20	BlackHawk XHD 20
Item #	F50-17	F51-17	F50-20	F51-20
Machine Size	17"	17"	20"	20"
Pad Size	16"	16"	19"	19"
Pad Speed	175 rpm	175 rpm	175 rpm	175 rpm
Amp Draw	5.9	6.5	6.1	6.8
Weight	94 lbs.	97 lbs.	94 lbs.	97 lbs.

## All Models

Motor	1.5 HP, dual capacitor AC
Power	115V-230V. 60 Hz (50 Hz Optional)
Power Cord	50 ft., (14-3) 2-piece commercial with cord lock
Drive System	Triple-planetary 10:1 helical-cut gears
Sound Level (Ave.)	62 dB - Meets GS42 standard

Subject to Change Without Notice



Remove/Install the Handle in 60 Seconds



Exclusive Pin-Set™ Handle Lock - 4 Height



Remove the Handle Mounting Pin w/o Tools

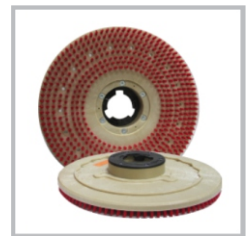

Includes Stiff Bristle Pad Driver



### Burnishing, Refinishing



The BlackHawk 1250 Burnisher drives a 20" pad at 1250 RPM for efficient polishing of all hard floor finishes. The 1.5 HP TEFC AC motor is powerful and is built with a shroud that protects the inner workings from dust and moisture.

AC motors require little maintenance, use less power and runs cleaner than DC motors. AC motors are less effected by heavy hands in operation, preventing trips to the circuit breakers. Preferred in buildings with older circuitry. The steel frame and 2-piece unit handle are durable and reliable.

1250 is popular in foreign markets. AC burnishers spinning at 1250 RPM are equivalent to a DC motor classified at 1500 RPM when its pad is in contact with the floor. Unlike DC motors, AC motor machine does not slow with added burnisher load. The BlackHawk 1250 AC is the perfect addition to any Green Cleaning program.

#### Power

- 1.5 HP, 56 frame, TEFC dual capacitor AC motor
- 115-230V, 60 Hz (50 Hz optional)
- 50 ft., (14-3) 2-piece commercial power cord with cord lock

#### Drive System

- V-Belt drives pads at constant 1250 RPM

#### Engineering Design

- Welded heavy gauge steel frame
- 2-piece powder-coated steel handle
- Molded plastic pad cover with gray wraparound bumper
- Comfortable vinyl-dipped foam handle grips
- Thumb-operated safety switch
- Negative pressure on/off switch. Dual steel operating triggers
- Multiple position handle adjustment
- Non-marking 1" x 5" non-marking ball bearing wheels
- Includes flexible pad driver with spring style pad centering clamp (#KIT2014).

#### Safety Features

- Quiet operation - 58 dB. Meets GS42 standard
- Built with UL listed components



### Specifications

<b>Model</b>	BlackHawk 1250
<b>Item #</b>	F56-20-02
<b>Motor</b>	1.5 HP, 56 frame, TEFC dual capacitor AC
<b>Drive System</b>	Multi V-Belt Drive
<b>Power</b>	115-230V, 60 Hz (50 Hz optional)
<b>Cord</b>	50 ft., (14-3) 2-piece commercial with cord lock
<b>Pad Size</b>	20"
<b>Pad Speed</b>	1250 RPM when in contact with floor
<b>Amp Draw</b>	14.5
<b>Weight</b>	90 lbs.
<b>Sound Level (ave)</b>	58 dB - Meets GS42 Standard

Subject to Change Without Notice

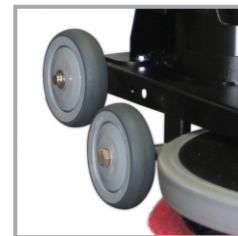

Easy Transport with 1"x 5" Non-Marking Tires



Includes Harpoon Style Pad Driver



Pull the Pin for Easy Handle Removal



2-Piece 50 ft. Power Cord with Molded Plug



## Burnishing, Refinishing



The BlackHawk 1500 Burnisher drives a 20" pad at 1500 RPM for efficient polishing of all hard floor finishes. The 1.5 HP 66 frame DC motor is powerful. The welded steel frame and chromed handle are durable and reliable.

### Power

- 1.5 HP, 66 frame, DC rectified motor
- 115V, 50/60 Hz power (230V option)
- 50 ft., (14-3) 2-piece commercial power cord with cord lock

### Drive System

- A 10-groove V-Belt drives pads at 1500 RPM

### Engineering Design

- Welded heavy gauge steel frame
- One piece chromed heavy-duty steel handle
- Molded plastic brush cover with wraparound bumper
- Thumb-operated safety switch
- Comfortable vinyl grips
- Negative pressure on/off switch. Dual steel operating triggers
- Multiple position handle adjustment
- Non-marking 1" x 5" non-marking ball bearing wheels
- Includes flexible pad driver with spring-style pad centering clamp (#KIT2014)

### Safety Features

- Quiet operation - 66 dB. Meets GS42 standard
- Built with UL listed components



ELKHART, IN



## Specifications

<b>Model</b>	<b>BlackHawk 1500</b>
<b>Item #</b>	F1500-20-BH
<b>Motor</b>	1.5 HP, 66 frame DC rectified motor
<b>Power</b>	115V, 50/60 Hz power
<b>Cord</b>	50 ft. (14-3) 2-piece commercial with cord lock
<b>Drive System</b>	Multi V-belt drive
<b>Pad Size</b>	20"
<b>Pad Speed</b>	1500 RPM
<b>Sound Level</b>	66 dB - Meets GS42 standard
<b>Weight</b>	92 lbs.

Subject to Change Without Notice

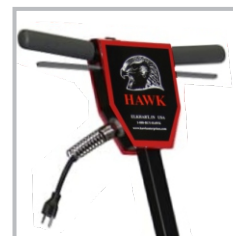

All Steel Construction  
Handle, Frames



Flexible Pad Driver  
with Pad Centering



Includes 20" Hogs Hair  
Pads and Centering  
Clamp



Optional Splash Guard  
#SPLASH20 - 20"





## Dry Floors, Circulate and Exhaust Air



**HAWK BVP25D**  
900 CFM Air Mover

The new HAWK BVP25D air mover is designed for small to medium size jobs. Ideal for ventilating hard to reach areas using its robust 1/4 HP induction motor and choice of three air flow positions. The 3-speed motor moves air up to 900 CFM.

Two 12 Amp auxiliary power outlets on the side-mounted control panel makes it easy to connect up to 5 unit in daisy chain operation. Quiet - 67 dB.

### Engineered Design

- 3-Speed, 1/4 HP motor
- 10 ft. 14 AWG power cord
- 3-speed switch and circuit breaker on control panel
- Up to 900 CFM air flow
- Two 12 Amp grounded auxiliary power outlets on the side-mounted control panel
- Use daisy chain in-line connection of up to 5 units for more effective, focused air flow
- Strong roto-molded chassis has a profile that allows for vertical stacking of up to 5 units for convenient storage
- Ergonomic handle for easy transport
- Lightweight 11.3 lbs.
- Quiet operation - 67 dB
- C-ETL-US certification
- 5 year warranty on roto-molded chassis. 2 year warranty on parts.



### Specifications

<b>Model</b>	BVP25D
<b>Motor</b>	1/4 HP, 115V, 60Hz
<b>Air Volume</b>	900 CFM (High), 700 CFM (Med), 690 CFM (Low Speed)
<b>Amp Draw</b>	2.1 Amp (High), 1.8 Amp (Med), 1.7 Amp (Low Speed)
<b>Air Flow Direction</b>	0, 45 and 90 degrees
<b>Max Static Pressure</b>	1.3"
<b>Frame Construction</b>	Sturdy Roto-molded Plastic
<b>Stackable</b>	5 units
<b>Daisy Chain</b>	Yes - Up to 5 Units
<b>Weight</b>	11.3 lbs. (net) / 12.6 lbs. (gross)
<b>Size (L x W x H)</b>	12.8" x 12.4" x 13.3"
<b>Attached Cord</b>	10 Ft. 14 AWG
<b>Sound Level (ave.)</b>	67 dB
<b>Certification</b>	C-ETL-US

Subject to Change Without Notice



Side Mount  
3-Speed Switch and  
Dual 110V Power Outlets



Daisy Chain up to  
5 Units for Extra Air  
Moving Power



Air Flow in 3 Angles  
0, 45 & 90 Degrees



Works in Tight Spaces  
for Tough Drying Jobs



## Dry Floors, Circulate and Exhaust Air



HAWK BVP50  
2820 CFM Air Mover



HAWK BVP50H  
with Handle and  
Transport Wheels

The HAWK BVP50 Air Mover is the safest and most efficient centrifugal air mover on the market. Our 1/2 HP motor moves air at up to 2820 CFM with just 4.5 amp draw.

Control the air flow and amp draw with our state of the art 2-speed moisture resistant switch. The roto-molded body is strong, lightweight and easy to clean, transport and stack. The BVP50H model adds a telescoping handle frame with transport wheels.

### Engineered Design

- The 1/2 HP, 2-speed motor is efficient and produces up to 2820 CFM airflow
- 25 ft. 16 AWG power cord
- The motor is sealed to prevent moisture from entering and damaging internal motor components
- The side-mounted 2-speed switch is moisture resistant
- Sturdy roto-molded plastic frame design has a profile that allows for vertical stacking up to 4 units for convenient storage
- The **BVP50** multipurpose design directs air at 3 angles (horizontally, 45° and 90°).
- The **BVP50H** adds a telescoping handle and transport wheels. Use horizontally, or tip back 90 degrees and move air straight upward.
- A plastic cage protects motor and fans from debris
- C-ETL listed
- 5 year warranty on roto-molded chassis. 2 year warranty on parts



### Specifications

<b>Model</b>	BVP50, BVP50H (w/ Handle & Wheels)
<b>Motor</b>	115V, 1/2 HP, 60Hz
<b>Attached Cord</b>	25 Ft. 16 AWG
<b>Air Flow</b>	2820 CFM (High Speed) / 2390 CFM (Low Speed)
<b>Amp Draw</b>	4.5 Amp (High Speed) / 2.8 Amp (Low Speed)
<b>Static Pressure</b>	2.5" Max
<b>Air Flow Direction</b>	0, 45 and 90 degrees
<b>Frame Construction</b>	Sturdy Roto-Molded Plastic
<b>Stackable</b>	4 units
<b>Weight</b>	25 lbs. (net) / 28 lbs. (gross)
<b>Size (LxWxH)</b>	22.5"x 20"x 13"
<b>Sound Level (ave.)</b>	74 dB
<b>Certification</b>	C-ETL-US

Subject to Change Without Notice



Store Up To  
5 Stacked Units



BVP50H Adds Dual  
Transport Wheels and  
Telescoping Handle



Direct Airflow at 3 Angles  
(0°, 45° and 90°).

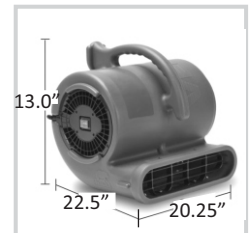

Compact Air  
Moving Power



## Dry Floors, Circulate & Exhaust Air

The HAWK Industrial Air Mover with 1/2 HP, 3-speed industrial motor moves air up to 2950 CFM. Built with super-tough polypropylene housing for long-term use in construction, manufacturing and housekeeping. Metal cage and safety discharge.

### Power

- 0.5 HP, 3 - speed motor.
- 115 V, 50/60 HZ power. 230V available
- 35 ft., (16-3) 2-piece commercial with cord lock
- Top mounted quick change 3-speed switch

### Engineered Design

- Three air flow speeds - 2000 , 2500 and 2950 CFM. Moves air up to 60 ft. at high speed
- Speed switch conveniently located next to lifting handle
- Continuous-duty rugged ball bearing motor
- Roto-molded polyethylene housing with lifetime warranty
- Plastic fan wheel
- Steel handle and discharge guard
- 8 rubber feet for non-slip positioning
- Stackable for easy storage
- Convenient size - 19.5" x 14.5" x 18.25"

### Safety features

- Quiet operation with dB sound levels: 59 dB (Low Speed), 62 dB (Medium Speed) and 64 dB (High Speed).
- UL Listed



*Moves Air at 3 Angles*



### Specifications

<b>Model</b>	<b>HAWK Industrial Air Mover</b>		
<b>Item #</b>	BH001-02 (Black Housing), BH001-08 (Blue Housing)		
<b>Motor</b>	0.5 HP, 3-speed 110V motor		
<b>Motor CFM</b>	2950 CFM	2500 CFM	2000 CFM
<b>Power Cord</b>	35 ft., (16-3) 2-piece commercial with cord lock		
<b>Auxiliary Outlet</b>	12 Amp with circuit breaker		
<b>Housing</b>	Roto-molded machine housing		
<b>Air Direction</b>	0, 45 and 90 degrees		
<b>Machine Size</b>	19.5" x 14.5" x 18.25"		
<b>Ship Size</b>	20" x 20" x 20"		
<b>Weight lbs.</b>	31l		
<b>Amp Draw</b>	5.3 Amp	4.5 Amp	4.3 Amp
<b>Sound Levels</b>	64 dB	62 dB	59 dB
	Meets Standards		



Moves Air Up to 60 ft. at High Speed



Compact Power 19.5" x 14.5" x 18.25"



Metal Carrying Handle

Subject to Change Without Notice





## Dry Floors, Circulate and Exhaust Air



The HAWK BPB25D Axial moves air efficiently with less power and effort than other models. A built-in GFC Auxiliary Outlet reduces risk of electric shock in wet areas. The BPB25D shoots a stream of air 50 feet ahead. An optional mounting stand locks onto the chassis and allows 360 degree rotation to move air in any direction.

### Power

- 2-Speed, 1/4 HP motor. A sealed motor design prevents moisture from entering and damaging internal motor components
- 25 ft., (14 AWG) power cord

### Engineered Design

- Axial design is efficient and produces up to 3320 CFM
- The metal air intake screen prevents objects from entering and damaging blades or motor
- Two 12 Amp GFCI grounded auxiliary power outlets on the side-mounted control panel. GFCI reduce the risk of electric shock in wet areas and is required by insurance companies paying for water flood cleanup claims
- Use daisy chain in-line connection of up to 5 units for more effective air flow
- 2-speed toggle switch with LED light on/off indicator
- Hour meter on control panel tracks hours of operation
- Strong roto-molded chassis has a profile that allows for vertical stacking of up to 5 units for convenient storage
- An optional folding metal frame with quick release locking knob allows easy adjustment for 360 degree airflow direction
- C-ETL US listed
- 5 year warranty on the roto-molded chassis. 2 year warranty on parts

### Specifications

<b>Model</b>	BPB25DA Axial
<b>Motor / Power</b>	1/4 HP, 2-Speed, 115V, 60 Hz Sealed Motor
<b>Motor CFM</b>	3320 CFM Max
<b>Amp Draw</b>	2.6 (High Speed), 1.3 (Low Speed)
<b>Power Cord</b>	25 Ft. 14 AWG with Molded Plug
<b>Air Flow</b>	Up to 3320 CFM
<b>Air Flow Direction</b>	360 Degrees with Optional Folding Metal Frame
<b>Meters</b>	LED Light Power Indicator, Hour Meter
<b>Size (H x W x L)</b>	20" x 13" x 22.5"
<b>Construction</b>	Sturdy Roto-molded Plastic
<b>Stackable</b>	5 units
<b>Daisy Chain</b>	Yes - Up to 5 Units
<b>Size (L x W x H)</b>	22.5" x 13" x 20"
<b>Weight</b>	30 lbs. (net) / 34 lbs. (gross)
<b>Sound Level (ave.)</b>	78 dB
<b>Certification</b>	C-ETL-US

Subject to Change Without Notice



Roto-molded Chassis has a Profile for Stacking and Convenient Storage



Optional Folding Metal Frame Directs Air at Every Angle



(2) GFCI Outlets and Convenient 2-Speed Switch



GFCI Shock-Preventing Outlets Make Daisy Chain Connection Easy



### Dry Floors, Circulate and Exhaust Air



**HAWK BH25AD Axial  
1720 CFM Air Mover**

The HAWK BH25AD Axial Air Mover produces up to 1720 CFM airflow with a variable control dial switch. The low amp draw and dual built-in 12 amp power outlets allows for multiple units to be used in daisy chain.

The metal rack/stand provides 360 degree rotation for multiple positions when drying surfaces or circulating air.

The specially designed blades and fan grille excel in extending a powerful and focused straight stream of air up to 60 feet.

#### Power

- 1/4 HP motor. 115V / 60 Hz
- The sealed motor design prevents moisture from entering and damaging internal motor components
- 20 foot power cord
- 1 year limited warranty

#### Engineering Design

- Axial design is efficient and produces up to 1700 CFM
- 360 degree adjustable positions
- Injection molded ABS housing is lightweight and durable
- Two 12 Amp GFCI grounded auxiliary power outlets on the side-mounted control panel. These outlets allow for daisy chain in-line connection of up to 3 units for more effective air flow
- GFCI outlets reduce the risk of electric shock in wet areas and is required by insurance companies paying for water flood cleanup claims
- Includes Rack Stand

#### Safety Features

- ETL/CETL certified.



### Specifications

<b>Model</b>	HAWK BH25AD
<b>Motor</b>	1/4 HP, 115V, 60Hz Sealed Motor
<b>Air Volume</b>	Adjustable 0 to 1720 CFM
<b>Amp Draw</b>	Low 1.6 Amp Draw
<b>Max Static Pressure</b>	2.5"
<b>Fan Blade</b>	(5) 16" ABS Molded Plastic Blades
<b>Housing</b>	Injection Molded ABS
<b>Unit Weight</b>	16.5 lbs.
<b>Unit Size (LxWxH)</b>	18.6" x 19.2" x 9.4"
<b>Box Weight</b>	19.6 lbs
<b>Box Size (LxWxH)</b>	19.7" x 17.7" x 10.4"
<b>Power Cord</b>	10 ft.

Subject to Change Without Notice



Stackable Chassis for Storage Only



Direct Air at Every Angle

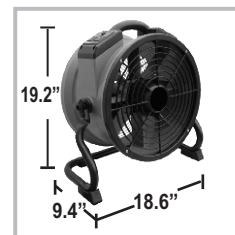

Moves Air Up To 60 Feet

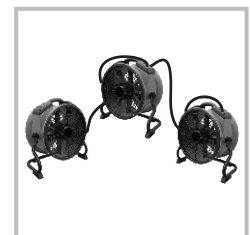

Move More Air with Daisy Chained Power



### Small to Large Area Vacuum

The HAWK V20, 20 gallon tank vacuum is built for years of trouble-free service. Ideal for recovery of liquid and solid wastes in all size cleaning jobs.

Rugged and durable for the professional cleaning market. Non-corrosive tank with large 12.5" top access makes dump and discard easy. Empty larger flowing liquid wastes with the 1.5" hose included. Available with optional front mount squeegee for improved performance.

#### Power

- 2 HP, 2-stage heavy duty bypass motor
- 110V (230V optional)
- 35 ft., (16-3) 2-piece commercial with cord lock

#### Engineered Design

- Non-corrosive tank with large 12.5" top access
- Tank is sized to hold a 5 gallon pail. Great for collecting and cleaning viscous liquids and slurries
- Large 5" rear wheels and strong 3" front casters
- Powder-coated steel handle and carriage
- An automatic liquid shut-off prevents motor flooding
- Includes 15 ft. flexible vacuum hose (#HPTV1060)
- Includes wet/dry tool kit (#HPVA002)
- Includes washable synthetic cloth dust bag (#HPWDH0001ASSY)
- Optional 30" front-mount squeegee (#HPV006FMS)

#### Safety Features

- Quiet operation - 68 dB. Meets GS42 requirements
- 1.5" quick drop drain hose prevents need for lifting
- UL / CUL listed components for safe performance



**V20**  
Wet/Dry  
Tank Vacuum



Includes:  
Wet/Dry Tool Kit  
#HPVA002

15' Flexible  
Vacuum Hose  
#HPTV1060



### SPECIFICATIONS

Item#	V20
Capacity	20 gallon
Wet Pick Up	16 gallons
Dry Pick Up	1.5 bushel (14 gallons)
Motor	2 HP DC, 2 Stage
Power	115V, 50/60 Hz
Amp Draw	10.7 Amp
Power Cord	35 ft. (16-3) 2-piece commercial w/cord lock
Water Lift	117 "
Air Flow	112 CFM
Wheels	(2) 6" rear, (2) 3" front
Weight	62 lbs.
Drain Valve	1.5 inch
Dimensions (HxDxW)	37" x 24.25" x 24"
Sound Level (ave.)	68 dB



Optional 30" Front  
Mount Squeegee  
#HPV006FMS



Washable Cloth  
Vacuum Bags  
#HPWDH0001ASS



Compact Tank  
Vac Design



5 Gallon Pail for  
Slurry Liquids

Subject to Change Without Notice





## Large Area Vacuum Cleaning



**Titan 29**



Includes:  
Wet/Dry Tool Kit  
#HPVA002

15' Flexible  
Vacuum Hose  
#HPTV1060



The HAWK Titan 29 and Titan 55 wet/dry tank vacuums are built for years of trouble-free service. Ideal for large volume recovery of liquids and solid wastes. Safely move heavy loads up to 400 lbs. on large rear wheels and industrial front casters. The corrosion-resistant tank is easy to rinse out through the 13" top entry hole. Drain liquids and debris from the rear-mounted quick-drop drain valve.

### Power

- 2 HP, 2-stage heavy-duty bypass motor (230V optional)
- 35 ft., (16-3) 2-piece commercial power cord with cord lock

### Engineered Design

- 112 CFM air flow. 117" water lift.
- Corrosion-resistant roto-molded tank is easy to clean
- Quick-drop drain valves - 1.5" (T29) and 3" (T55)
- V29 - Large 8" rear wheels and strong 4" front casters
- V55 - Large 10" rear wheels and strong 5" front casters
- Powder-coated steel handle and carriage
- The automatic liquid shut-off valve prevents motor flooding
- Quick drop drain hose reduces need for lifting
- Includes wet/dry tool kit (#HPVA002)
- Includes 15ft. flexible vacuum hose (#HPTV1060)
- Includes one acid and mildew resistant, non-pleated washable synthetic cloth dust bag (#HPVA4040) and mounting ring (#VA2018)

### Safety Features

- Quiet operation - 68 dB. Meets GS42 requirements
- Built with UL / CUL approved components

## SPECIFICATIONS

Model	Titan 29	Titan 55
Item #	V29-V	V55-V
Capacity	29 gallon	55 gallon
Wet Pick Up	22 gallons	48 gallons
Dry Pick Up	2 bushel (18.6 gal)	4 bushel (37.2 gal)
Motor	2 HP DC, 2-Stage	2 HP DC, 2-Stage
Power	115V, 50/60 Hz	115V, 50/60 Hz
Amp Draw	10.7 Amp	10.7 Amp
Power Cord	35 ft., (16-3) 2-piece	35 ft., (16-3) 2-piece
Water Lift	117"	117"
Air Flow CFM	112	112
2 Wheels - Rear	8"	10"
2 Casters - Front	4"	5"
Weight	80 lbs	94 lbs
Drain Valve	1.5"	3"
Dimensions (HxDxW)	40" x 33.5" x 20.5"	45" x 38" x 25.5"
Sound Levels (ave.)	68 dB	68 dB

Subject to Change Without Notice



**Titan 29**  
Tank Vacuum



**Titan 55**  
Tank Vacuum



Quick-Drop  
Drain Valves  
1.5" (V29)  
3" (V55)



Wheels, Casters &  
Molded Tank are  
Mounted on Strong  
Steel Frame



## Portable Vacuum Cleaning



Harrier 1

Includes Tool Kit  
#HPV-Back-1.5L KIT

Carry vacuum cleaning power on your shoulders. The top fill design on the lightweight, compact HAWK Harrier Backpack Vac will prevent clogging so you can optimize your cleaning time.

The 6.5 quart tank capacity extends time. The large-area, triple-filtration design keeps dirt in the canister and out of the air. The ergonomic construction of the 10.5 lb. vacuum makes it ideal for cleaning in small and large areas.

### Power

- 1-Stage motor with thermal protection
- 35 ft., (16-3) 2-piece commercial with cord lock

### Engineered Design

- Roto-molded polyethylene housing is tough, durable and easy to clean. Lifetime housing warranty
- Lightweight - 10.5 lbs. machine reduces user fatigue
- Carry the backpack on your back with the comfortable harness and padded shoulder straps. Quick-lock adjustable strip fasteners make it easy to wear
- Exceptional filtration capability. The Harrier I captures fine particles and helps improve air quality
- 8 rubber feet for maximum, diffused air exhaust
- Use with the disposable paper filter bags (#HPVA005-3) or washable cloth filter (#HPV-BACK-CLTH-BAG)
- Complete tool kit includes flex hose, telescopic wand, round dusting brush, two-way flat floor tool for hard and soft floor, crevice tool and detail tool

### Safety

- 72 dB quiet operation
- Built with UL Listed components



## Specifications

Model	Harrier I
Item #	V001-H1-115
Motor	1 stage, 1120 Watt motor
Power	115V, 50/60 Hz power (230V option)
Power Cord	35 ft., (16-3) 2-piece commercial w/ cord lock
Amp Draw	7.0
Water Lift	96"
Air Flow CFM	144
Housing	Roto-molded Polyethylene
Size	8" x 9" x 21"
Tools	4 tools plus 2 piece curved wand
Sound Level (ave.)	72 dB

Subject to Change Without Notice



Powerful 1-Stage  
Motor

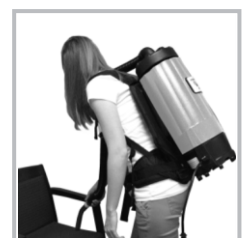

Lightweight Power



Disposable Paper  
Vacuum Bags  
#HPVA005-3



Washable Cloth Bags  
#HPV-BACK-CLTH  
BAG



## Portable Extraction Cleaning

The HAWK Mini-Vactor is more than an ordinary spotter. This affordable, powerful, compact unit is designed for superior carpet and upholstery cleaning. The model with in-line water heater makes cleaning faster.



### Power

- 1 HP, 2-Stage vacuum motor. 110V, 60 Hz
- Model with in-line water heater use a 13 Amp, 700W heater to produce 130°F clean solution
- 16 ft. (14-3) power cord with molded-in cord wrap

### Engineered Design

- 3.1 gal. solution tank, 3.5 gal. recovery tank
- 45 psi oscillating vacuum pump
- Two aluminum lock holds the solution tank to the recovery tank
- Float ball shut-off in the recovery tank protects the vacuum motor from water damage
- Spin-off cover on the lift-off recovery tank makes cleaning and rinsing easy
- 3-position switch allows the operator to choose the pre-spray mode with no vacuum, the spray and vacuum mode, and the vacuum only mode
- Includes 4" stainless steel hand wand
- Includes 8 ft. vacuum and solution hoses
- Optional 2-piece, stainless-steel wand with 8 inch head, 10 ft. vacuum hose and solution hose (#EXTCR-WAND-10SS)

### Safety Features

- Quiet operations - 58 dB. Meets GS42 standard.



ELKHART, IN



### Specifications

Model	Hot Shot Mini-Vactor w/Heat	Hot Shot Mini-Vactor w/o Heat
Item #	EXT-3H	EXT-3NH
Amp Draw	13 Amp	8.5 Amp
Heater Power	700W, 130 degrees F	—
Both Models		
Motor	115 V, 60 Hz, 3-Position Power Switch	
Solution Tank	3.1 Gallons	
Recovery Tank	3.5 Gallons	
Water Lift	85"	
Solution Pump	Oscillating Type, 45 PSI	
Power Cord	25 ft. (16-3) Commercial Cord	
Dimensions LxWxH	9" x 18" x 20"	
Weight	27 lbs. (Extractor, Wand, Hose, Power Cord)	
dB Rating	58 dB	---

Specifications subject to change without notice



Optional Vacuum Wand Set  
**XTCR-WAND-10SS**



3.1 Gallon Solution Tank is Easy to Fill



Recovery Tank Lifts Off



3.5 Gallon Recovery Tank is Easy to Empty and Rinse





## Large Area Floor Finish Applicator

The HAWK Flight Applicator glides across the floor as it applies water-based and solvent-based finishes, restorers and disinfectants in a smooth, even, crystal-clear coat.

Available with 3 aluminum applicator head sizes - 28", 36" and 48" wide - delivering solutions to the floor at up to 27,500 square feet per hour. The patented, variable-flow control pump can reduce finish usage by up to 20%.

No spills, no drips, no baseboard splashes. Even novice users can perform like a pro.

### Engineering Design

- 12 V battery-powered 70 psi solution pump delivers finishes to the floor through the aluminum applicator bar
- Patented variable flow control switch and a master on/off switch is at your finger tips
- 8" wheels with a magnetic sensor activates the pump as you pull the Flight Applicator across the floor
- Use a lambs wool applicator with added 3" synthetic yarn pad to spread solvent-based finishes
- Use a microfiber applicator pad to apply water-based finishes. (Always check the finish product label for the recommended pad type.)
- Hook and loop design easily mounts pads to the applicator bar
- The corrosion-resistant, powder-coated frame is 21" wide x 33.5" deep and holds up to (2) 2.5 gallon bottles or (1) 5 gallon pail
- A pin-locked handle height adjusts from 32" to 40" high, fitting the user's height
- Easy to rinse and clean. Applicator bar and pad disconnects for convenient storage.



### Specifications

Model	Flight 28	Flight 36	Flight 48
Item #	F-HF-28	F-HF36	F-HF-48
Aluminum Head Size	28"	36"	48"
Application per Hour	15,000 sq.ft.	20,000 sq.ft.	27,500 sq.ft.
Pump / Motor	70 PSI	70 PSI	70 PSI
Frame Construction	Corrosion-resistant, Powder Coated Steel Frame		
Frame Dimension	21.2" x 21" x 33.5"		
Adjustable Handle	32" to 40" High		
Pad with Twisted Synthetic Yarns			
(1) Microfiber Pad	#HVMFP28	#HVMFP36	#HVMFP48
(1) Lambs Wool	#HVLWP28	#HVLWP36	#HVLWP48
Warranty	1 Year Pump and Motor - 3 Years Steel Frame		

Subject to Change Without Notice



Battery Powered Pump Moves Finishes from Pail to Floor

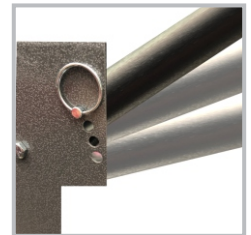

Pin-Lock Handle Adjusts from 33" to 40" High



28", 36" & 48" Microfiber Pads with Hook & Loop Mounting



28", 36" & 48" Lambs Wool / Yarn Pads Fit on Applicator Bar



### Spotting, Tight Spaces, Baseboards, Stairs



The HAWK Talon Edger Floor Machine is designed to scrub built-up dirt in corners and on baseboards without bending and back-breaking effort. Scrub with pads or with optional bonnets or brushes. Includes the pad driver and an assorted pad startup kit.

**Power**

- 1/8 HP, DC motor
- 115V, 50/60 Hz power
- 35 ft., (16-3) 2-piece commercial with cord lock

**Drive System**

- Enclosed durable gear belt drives brushes and pads at 500 RPM

**Engineered Design**

- 2 sizes - 6" and 8"
- Handle adjusts from 47" to 52" with height control knob
- Rotational molded polyethylene housing
- The brush drive is injection molded. Drive is reinforced resin with the unique Mag-Lok™ magnetic system to securely mount brushes and pad drivers without tools
- Optional bristle brushes, pad fiber pads and bonnets

**Safety Features**

- Quiet operation
- Built with UL approved components



Red Scrub  
6" AS009-CS  
8" AS009-8CS

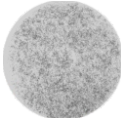

White Polish  
6" AS011-CS  
8" AS011-8CS

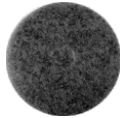

Black Strip  
6" AS010-CS  
8" AS010-8CS

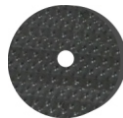

Pad Driver (1)  
6" AS003  
8" AS003-8

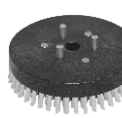

Nylon (1)  
6" AS002  
8" AS002-8



Grit (1)  
6" AS005  
8" AS005-8



Nylon Edger (1)  
6" AS006  
8" AS006-8

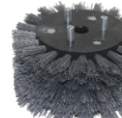

Grit Edger(1)  
6" AS001  
8" AS001-8



Bonnet (6)  
6" AS008-6  
8" AS008-8

### Specifications

Model	Talon-6	Talon-8
Item #	F06-06-02	F06-08-02
Brush Size	6"	8"
Dimensions L x W x H	11" x 6" x 47" Adjusts to 52"	11" x 8" x 47" Adjusts to 52"

### Both Machines

Motor	1/8 HP, 115V DC
Power	115V, 50/60 Hz 1.1 Amp draw.
Power Cord	35 ft., (16-3) 2-piece commercial with cord lock
Brush Speed	500 RPM
Brush Mount	Mag-Lok™
Housing	Molded high density plastic
Weight	10.5 lbs.

Subject to Change Without Notice



Talon Scrubs in Tight Spaces

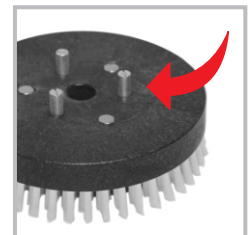

Mag-Lok™ 3 Steel Drive Pins Mount Brushes



Adjustable Handle Height Locks to Position



Talon Tools Strip, Scrub & Polish



## Scrub and Polish Tight Spaces

The HAWK Twin Talon was born out of need for affordable compact power. Dual 1/8 HP motors spin twin heads at 500 RPM in opposing direction. The result is very controllable polisher with a low center of gravity.

The Twin Talon is small enough to work on counter tops but large enough to polish a small bathroom floor. Available in three sizes. The 36" removable handle (optional) mounts over the hand grips and lets you stand while using the Twin Talon as an edger, carpet spotter and a floor scrubber.

### Engineered Design:

- Compact 22.5 lbs. design
- 3 sizes (12", 14", & 16")
- The 14" model is designed for use with 7" diamond
- 1/8 HP Dual Motors
- Exclusive Mag-Lock™ brush and driver attaching system
- Durable resin cover over steel frame for reliable performance
- Quiet belt drive power
- Simple operator switch for both hand or foot operation
- 35 ft., (16-3) 2-piece commercial with cord lock
- Wide selection of drivers & specialty brushes (listed below)
- UL / CUL listed components for safe performance



Red Scrub  
6" AS009-CS  
8" AS009-8CS

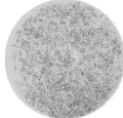

White Polish  
6" AS011-CS  
8" AS011-8CS

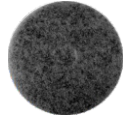

Black Strip  
6" AS010-CS  
8" AS010-8CS



Pad Driver (1)  
6" AS003  
8" AS003-8

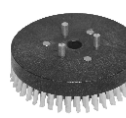

Nylon (1)  
6" AS002  
8" AS002-8



Grit (1)  
6" AS005  
8" AS005-8



Nylon Edger (1)  
6" AS006  
8" AS006-8

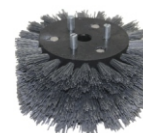

Grit Edger(1)  
6" AS001  
8" AS001-8



Bonnet (6)  
6" AS008-6  
8" AS008-8

## Specifications

Model #	Twin Talon 12	Twin Talon 14	Twin Talon 16
Item #	F86-12	F86-14	F86-16
Pad Size	6"	6"	8"
Brush Size	6"	6"	8"
Motor	1/8HP DC Rectified, 115V, 50/60 Hz		
Brush Speed	Dual Belt Drive, 500 RPM		
Power Cord	35 ft., (16-3) 2-piece commercial with cord lock		
Amp Draw	5.0 Amp	5.5 Amp	6.0 Amp
Weight	22.5 lbs.	22.5 lbs.	22.5 lbs.

Subject to Change Without Notice



Hand Polishing of  
Hard Surfaces



Carpet Spotting  
and Detail





## High Speed Polish of Hardest Floors



The HAWK Propane Burnisher is an ultra-high speed machine that gives floor care professionals the performance features of higher priced units in one affordable package. Available in two widths and two builds. Rugged, reliable, easy-to-use, and economical.

### Power

- Kawasaki 18 HP propane motor with electric start
- Premium fuel regulating system
- Engine is EPA and CARB certified
- California-rated emissions system on Kawasaki engines
- Electric or battery engine start options

### Engineered Design

- Heavy duty, American made aluminum deck casting
- Adjustable caster wheels for fine tuning of pad pressure
- Belt drive transmission turns pads at 2000 RPM (21") or 1700 RPM (28") models
- Flexible pad drivers provide excellent pad to floor contact
- Oversize drive bearing
- Handle is ergonomically designed, adjusts easily for operator comfort
- Premium catalytic muffler
- Heavy-duty steel 20 lb. propane tank
- Modular change components
- Available in Dust Collection models
- Available in a Clutch Drive models

### Safety Features

- Quiet < 89 dB operation
- UL/CUL listed starter and ignition for safety assurance

## Specifications

Model	HPP21	HPP21DC	HPP27	HPP27DC
Part #	F0028	F0028DC	F0029	F0029DC
Machine Size	21"	21"	28"	28"
w/ Clutch	No	Yes	No	Yes
w/ Dust Control	No	Yes	No	Yes
Kawasaki Motor	18 HP	18 HP	18 HP	18 HP
Motor Speed	3600 RPM	3600 RPM	3600 RPM	3600 RPM
Pad Size	21"	21"	28"	28"
Pad Speed	2000 RPM	2000 RPM	1700 RPM	1700 RPM
Drive System	Belt drive	Belt drive	Belt drive	Belt drive
Productivity	25,000	25,000	33,000	33,000
	sq. ft./hour	sq. ft./hour	sq. ft./hour	sq. ft./hour
Machine Size	22.8" x 48"	22.8" x 48"	32.5" x 64.2"	32.5" x 64.2"
Steel Tank	20 lbs.	20 lbs.	20 lbs.	20 lbs.
dB Rating	< 89 dB	< 89 dB	< 89 dB	< 89 dB
Weight	187 lbs.	187 lbs.	200 lbs.	200 lbs.

Subject to Change Without Notice



Adjustable Height  
Ergonomic  
Handle for Operator



V-Belt Drives Pads  
at 2000 RPM



Optional Splash Ring



Optional Active Dust  
Control Kit



### Cutting, Polishing, Scraping

The HAWK CLAW Diamond Pad Driver provides peak grinding and polishing results to the natural stone and concrete tradesman. The CLAW is available in five sizes - 10", 13", 15", 17", and 20", driving both 3" round tools, and trapezoidal tools.

Diamond tools are held in milled recesses in the CLAW plate with the unique Mag-Lok industrial magnet system. Grinding and polishing tools mount securely on the plate, yet are easy to change without shop tools.

Operating vibrations are reduced by Neoprene rubber vibration damping isolators built into the mounting system with a custom milled aluminum clutch plate. Power the CLAW with your severe-duty 1.5 HP rotary floor machines.

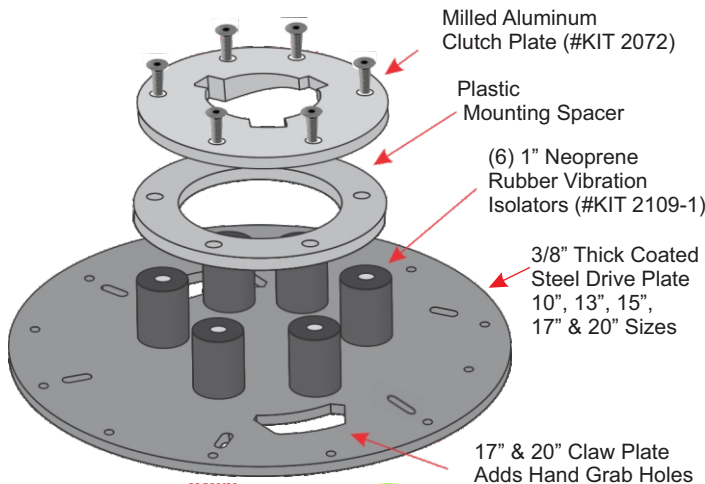
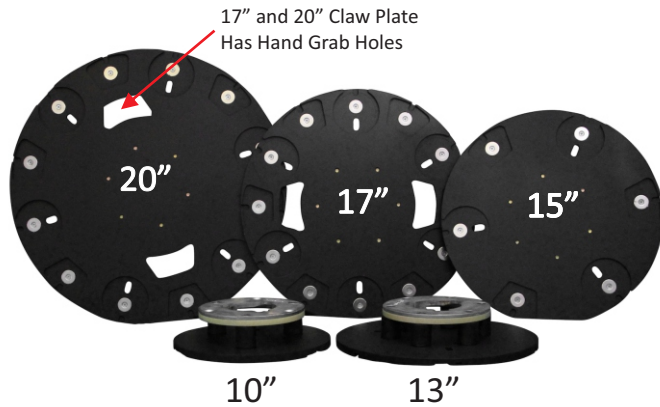

#### Engineered Design:

- The weighted CLAW plate is built with 3/8" plate steel, powder-coated for corrosion resistance and easier clean up
- The face of the CLAW plate is milled with round and trapezoidal tool mounting recesses, each fit with a Mag-Lok industrial magnet
- The top of the CLAW plate is fit with a custom milled aluminum NP9200 clutch plate, sitting on top of six 1" Neoprene rubber vibration isolators. These isolators reduce vibration and flex over high points and lippage
- Round 3" resin tools mount securely on a 3" metal adaptor plate with hook and loop face. The adaptor and tool combination mounts onto the CLAW plate recess with the Mag-Lok System. Order tools separately
- The 17" and 20" CLAW plates add hand grab holes for easier, safer handling
- Includes round and trapezoidal steel hole blanks that fit in the unused recesses. Filling the unused hole recesses prevent debris buildup
- Includes 3" steel mounting adapters with hook and loop mounting. Order additional adapters (#KIT2018-1 - Set of 6), or the replacement hook face sheet (#KIT2018 - Set of 6).



Includes Round Tool Adapters and Metal Hole Blanks to Fit the Milled

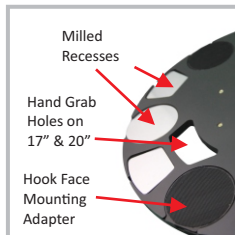

CLAW Steel Plates are Milled with Tool Mounting Recesses



3" Round Resin Tools Mount Fast and Reliably



CLAW Drives 3" Round and Trapezoidal Tools

### Specifications

Tool	CLAW 10	CLAW 13	CLAW 15	CLAW 17	CLAW 20
Item #	#Claw10	#Claw13	#Claw15	#Claw17	#Claw20
Claw Size	10"	12-5/8"	15"	16-5/8"	19-5/8"
3" Round Tools	3	3	3	6	6
3" Round Blanks (Included)	3	3	3	6	6
Trapezoid Tools	0	3	3	6	6
Trapezoid Blanks (Included)	0	3	3	6	6
Tool Mounting	Mag-Lok Industrial Magnet System				
Weight	11 lbs.	18 lbs.	25 lbs.	27 lbs.	39 lbs.

Subject to Change Without Notice



## Professional Polishing of Concrete & Stone



HAWK Orbitec Shown with  
Electroplated Plate and  
3" Replaceable Diamond Resin Tool  
(Order Tools Separately)



Orbitec Top View Shows  
Replaceable Pedestal and  
Milled Steel Clutch Plate



The HAWK Orbitec Planetary Driver makes quick work of polishing large concrete and stone areas. Six independent sealed ball bearing pedestals spin 3" tools up to 400 RPM. Orbitec extends tool life through cool running. The counter-rotating heads work 60% faster than fixed tool drivers.

### Engineered Design

- The Orbitec Driver mounts under most conventional design 1.5 HP floor machines, driving the Orbitec plate in a clockwise direction.
- The Orbitec mounting pedestals spin 3" diamond tools at 400 RPM in a counter-clockwise direction. This counter rotating operation spins diamond tools 60% faster than fixed mount drivers.
- The custom milled steel clutch plate provides easy on-and-off mounting on your floor machine
- Three plate sizes; 13", 17" and 20"
- The electroplated 1/2" thick steel drive plate is built with replaceable pedestal heads. Black electrostatic coating resists corrosion.
- These pedestals with are built with tool-holding hook facing, securely mounting round diamond tools with loop backing. Diamond tools are quickly changed without shop tools
- Add the optional dust ring and vacuum hose mounting kits to your HAWK floor machine for dust containment
- Add optional machine weights to your HAWK severe-duty floor machine for greater down pressure and faster floor prep results
- Replacement 3" pedestal with hardware **#HP0017-HEAD3**
- Order diamond tools separately

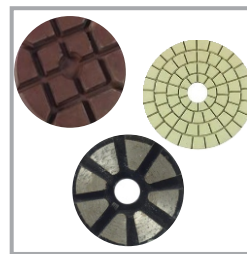

Purchase Grinding  
and Polishing  
Wheels Separately

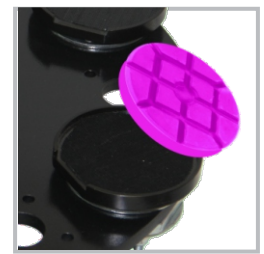

Hook & Loop  
Mounting of Tools on  
Pedestals

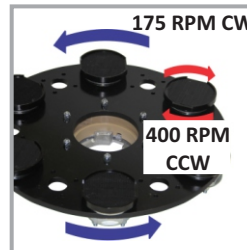

Driver Rotates at 175 RPM  
Tools Counter-Rotate  
at 400 RPM

### Specifications

Model	13" Orbitec Tool Driver	17" Orbitec Tool Driver	20" Orbitec Tool Driver
Item#	HP0013	HP0017-3	HP0020-3
Plate	13"	17"	20"
Driver Diameter	12.5"	16.5"	19.5"
Machine Required	1.5 HP / 175 RPM Severe-Duty Floor Machine		
Machine RPM	165	165	165
Tool RPM	400	400	400
Weight	25 lbs.	46 lbs.	64 lbs.

Subject to Change Without Notice





The Private Branding Order Form makes it easy to build the EXACT machine that you want.

- Select the machine model, working size, power voltage and motor type and size.
- Customize the model with factory-installed accessories like special dust control assemblies, weights, splash guards and aftermarket accessories.
- Power Cords - select the power cord strength, color (yellow, black or gray), and length.
- Motor and Handle Labels - HAWK sends you label specifications for your design and production, or we can design with your colors, logo and contact information.
- Colors - Select from 7 standard colors or chromed brush covers.
- Special colors and design are available with set minimum quantities.

The HAWK Private Brand System combinations produce hundreds of products. Our sales reps can help you fill out the form for the exact results you demand.

## HAWK ENTERPRISES PRIVATE BRANDING ORDER FORM

<small>DATE RECD</small>	<small>RECVD BY</small>	<small>OFFICE USE ONLY</small>	<small>CUSTOMER ID</small>
<small>Click here to enter date.</small>		<small>PART NUMBER</small>	<small>B.O.M. BUILT</small>
<small>COMMENTS:</small>			

**WARNING THIS DOCUMENT CONTAINS CONFIDENTIAL INFORMATION**  
**\*\*IMPORTANT NOTICE\*\***

Please complete this document in its entirety with the most accurate information possible. This will ensure there are no miscommunications between our customers and Hawk Enterprises. Partial forms WILL NOT be accepted for review. *Your company representative must sign in the provided locations throughout this document for it to be considered valid!*

CUSTOMER INFORMATION			
<small>COMPANY NAME:</small>		<small>COMPANY CONTACT INFORMATION</small>	
<small>ADDRESS:</small>		<small>FIRST:</small>	<small>LAST:</small>
<small>SUITE:</small>	<small>P.O. BOX</small>	<small>PHONE:</small>	<small>EXTENSION:</small>
<small>CITY:</small>	<small>STATE:</small>	<small>ZIP CODE:</small>	<small>EMAIL:</small>
<small>PHONE:</small>		<small>FAX:</small>	

### STANDARD FLOOR MACHINE

STEP 1: MACHINE SIZE				
<small>10 INCH</small> <input type="checkbox"/>	<small>13 INCH</small> <input type="checkbox"/>	<small>15 INCH</small> <input type="checkbox"/>	<small>17 INCH</small> <input type="checkbox"/>	<small>20 INCH</small> <input type="checkbox"/>

STEP 2: MOTOR OPTIONS				
HORSEPOWER	VOLTAGE	FREQUENCY	GEARBOX	COLOR
<small>1.0HP</small> <input type="checkbox"/>	<small>115v</small> <input type="checkbox"/>	<small>60hz</small> <input type="checkbox"/>	<small>STANDARD</small> <input type="checkbox"/>	<small>CHROME</small> <input type="checkbox"/>
<small>1.5HP</small> <input type="checkbox"/>	<small>230v</small> <input type="checkbox"/>	<small>50hz</small> <input type="checkbox"/>	<small>XTRA HEAVY DUTY</small> <input type="checkbox"/>	<small>BLACK</small> <input type="checkbox"/>
*1.0HP MOTORS ARE ONLY AVAILABLE IN CHROME				

STEP 3: SPECIAL MACHINE OPTIONS				
<small>PRO SERIES</small> <input type="checkbox"/>				
*PRO SERIES AUTOMATICALLY SELECTS:				
<small>-LONG CONNECTING LEGS</small>	<small>-UPPER CAM LOCK</small>	<small>-SOLUTION TANK</small>	<small>-SPLASH GUARD</small>	<small>-PAD DRIVERS</small>

STEP 4: FRAME COLOR SELECTION		
<small>BLACK</small> <input type="checkbox"/>	<small>HAMMERSILVER</small> <input type="checkbox"/>	<small>RED</small> <input type="checkbox"/>

STEP 5: BRUSH COVER OPTIONS					
COLOR		BUMPER COLOR		SPECIAL OPTIONS	
<small>RED</small> <input type="checkbox"/>	<small>BLACK</small> <input type="checkbox"/>	<small>CHROME</small> <input type="checkbox"/>	<small>GREEN</small> <input type="checkbox"/>	<small>BLACK</small> <input type="checkbox"/>	<small>INTERCHANGEABLE</small> <input type="checkbox"/>
<small>MOODY BLUE</small> <input type="checkbox"/>	<small>ORANGE</small> <input type="checkbox"/>	<small>TEAL</small> <input type="checkbox"/>	<small>YELLOW</small> <input type="checkbox"/>	<small>GRAY</small> <input type="checkbox"/>	
<small>ROYAL BLUE</small> <input type="checkbox"/>	<small>HAMMERSILVER</small> <input type="checkbox"/>	<small>ROYAL BLUE</small> <input type="checkbox"/>	<small>ROYAL BLUE</small> <input type="checkbox"/>	<small>RED</small> <input type="checkbox"/>	
**SOME COLORS MAY REQUIRE MINIMUM QUANTITY ORDER					

GAUGE	COLOR	LENGTH	STYLE
<small>12-3</small> <input type="checkbox"/>	<small>ONLY YELLOW</small>	<small>75FT.</small> <input type="checkbox"/>	<small>100FT.</small> <input type="checkbox"/>
<small>14-3</small> <input type="checkbox"/>	<small>GRAY</small> <input type="checkbox"/>	<small>SOFT.</small> <input type="checkbox"/>	<small>75FT.</small> <input type="checkbox"/>
	<small>YELLOW</small> <input type="checkbox"/>	<small>100FT.</small> <input type="checkbox"/>	<small>NOSTYLE OPTIONS</small>
			<small>1pc</small> <input type="checkbox"/>
			<small>2pc</small> <input type="checkbox"/>

STEP 10: SWITCHBOX COVER OPTIONS					
STYLE	COLOR				
<small>ANGLE</small> <input type="checkbox"/>	<small>SQUARE</small> <input type="checkbox"/>	<small>RED</small> <input type="checkbox"/>	<small>CHROME</small> <input type="checkbox"/>	<small>BLACK</small> <input type="checkbox"/>	<small>GREEN</small> <input type="checkbox"/>
<small>ROUND</small> <input type="checkbox"/>	<small>CE</small> <input type="checkbox"/>	<small>MOODY BLUE</small> <input type="checkbox"/>	<small>ORANGE</small> <input type="checkbox"/>	<small>TEAL</small> <input type="checkbox"/>	<small>YELLOW</small> <input type="checkbox"/>
					<small>ROYAL BLUE</small> <input type="checkbox"/>
					<small>HAMMERSILVER</small> <input type="checkbox"/>

LABELING OPTIONS	
<small>NO</small> <input type="checkbox"/>	<small>YES</small> <input type="checkbox"/>
<small>IF YES PLEASE SPECIFY:</small>	
<small>ENGLISH</small> <input type="checkbox"/>	
<small>SPANISH</small> <input type="checkbox"/>	

### STEP 11: ACCESSORIES

SOLUTION TANK	
<small>NO</small> <input type="checkbox"/>	<small>YES</small> <input type="checkbox"/>
<small>NATURAL</small> <input type="checkbox"/>	<small>BLACK</small> <input type="checkbox"/>
<small>ROYAL BLUE</small> <input type="checkbox"/>	<small>MOODY BLUE</small> <input type="checkbox"/>
<small>RED</small> <input type="checkbox"/>	<small>CHARCOAL</small> <input type="checkbox"/>
	<small>YELLOW</small> <input type="checkbox"/>

WEIGHTS	
<small>FRAME WEIGHT (20LBS)</small> <input type="checkbox"/>	<small>HORSESHOE WEIGHTS</small> <input type="checkbox"/>
<small>NO</small> <input type="checkbox"/>	<small>YES</small> <input type="checkbox"/>
<small>25LB</small> <input type="checkbox"/>	<small>36LB</small> <input type="checkbox"/>
*NOTICE: YOU CANNOT COMBINE FRAME WEIGHTS WITH HORSE WEIGHTS	
**ONLY AVAILABLE ON 17 INCH AND 20 INCH MACHINES	

EXTRA WEIGHTS	
<small>10LB</small> <input type="checkbox"/>	<small>25LB</small> <input type="checkbox"/>
*NOTICE: ADDING WEIGHT TO YOUR MACHINE AUTOMATICALLY ADDS THE WEIGHT PINK KIT	

OTHER ACCESSORIES	
<small>SPLASH GUARD</small>	<small>DUST CONTAINMENT SYSTEM</small>
<small>NO</small> <input type="checkbox"/>	<small>NO</small> <input type="checkbox"/>
<small>WITH LIP</small> <input type="checkbox"/>	<small>YES</small> <input type="checkbox"/>
<small>(FOR WEIGHTED MACHINES)</small>	



## Scraping, Soil & Coatings Removal

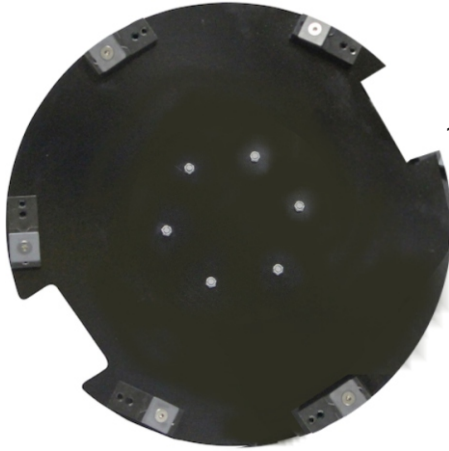

19" Steel Plate  
for 17" &  
20" Floor  
Machine

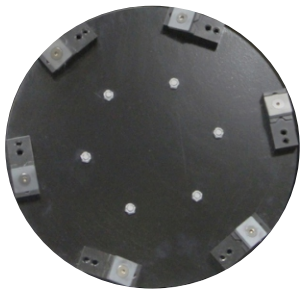

12" Steel Plate  
for 13" Floor  
Machine

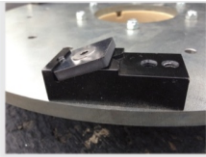

Standard Blade  
Mount for  
Wide Cutting Edge



45° Mount for  
Sharp Cutting Point

Use the HAWK Scraper to remove tile adhesives, carpet backing, industrial grease & soil, and coatings from hard surfaces. The Scraper drives six 1"x1" carbide steel cutters on a dual-position rigid mount to scrape and scratch surfaces.

Drive the Scraper with a HAWK severe-duty, 175 RPM floor machine with a 1.5 HP motor. Higher speed machines are not recommended.

### Engineered Design

- Three sizes; 13", 17" and 20"
- 3/8" thick steel plate construction. The plate is e-coated resists corrosion
- The plate is fit with six (6) tungsten steel cutter head holders, mounted with easily removed allen head screws
- Each cutter head holder carries one (1) 1" x 1" carbide cutting blade. Each blade has 8 cutting edges
- Mount the blade with a wide cutting edge, or turn 45 degrees to create a sharp cutting point (See photo at left.)
- The Scraper plate mounts on the floor machine with a custom milled aluminum clutch plate with a riser (included)
- The aluminum clutch plate won't seize onto the drive hub
- Add the optional dust ring and vacuum mounting kits on your HAWK severe-duty floor machine for handling dusty soils
- Add the optional machine weights for greater down pressure and faster scraping results

### Safety Tips:

- 17" and 20" Scrapers are built with mounting grip recesses for safer handling and mounting
- Always unplug the floor machine before mounting or removing the Scraper driver



ELKHART, IN



## Specifications

Model	Scraper 13"	Scraper 17"	Scraper 20"
Item #	#HP0034	#HP0033	#HPA0035
Floor Machine Size	13"	17"	20"
Scraper Plate Size	12"	16"	19"
Weight	27 lbs.	36 lbs.	39 lbs.
Cutter Blade Size	1.0" x 1.0" x 1/4"		
Clutch Plate	Custom Milled		
Riser	1.25" Tall Plastic		
Floor Machine	1.5 HP Severe-Duty with 11:1 Industrial Gears		

Subject to Change Without Notice

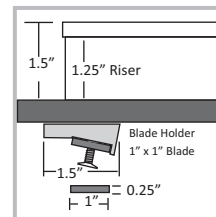

1" x 1" Blades Mount on the Holder with SS Bolts

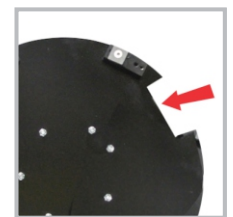

17" and 20" Have Built-In Mounting Grip Recess



Carbide Steel Blades (3) per Replacement Kits

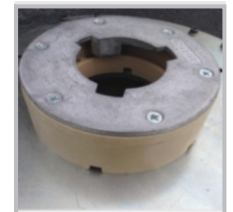

Scraper Mounts on Hawk Floor Machine with 9200 Style Clutch Plate



**Rotary Floor Machine Accessories**



**Dust Pickup Systems**  
for 66 Frame Motors  
#HP0031-DC17-  
STANDKIT



**Dust Pickup System** for  
180 Frame TE Motors  
Rotary Machine Models  
#HP0031-DC17-  
BRUTEKIT  
#HP0031-DC20-  
BRUTEKIT



**Dust Pickup Systems**  
for All Floating Head  
Rotary Design Models  
#HP0031-DC17-  
GLIDE



**Vacuum Assembly**  
Kit  
#Th1011



**Splash Guard**  
#SPLASH13 - 13"  
#SPLASH15 - 15"  
#SPLASH17 - 17"  
#SPLASH20 - 20"



**Splash Guard**  
SPLASH17-WD -17"  
SPLASH20-WD - 20"  
For Glide, Merlin  
Machines



**Hexagonal Weight**  
for Rotary Motor  
Mount  
#HPA0028-10P - 10 lbs.  
#HPA0028-25P - 25 lbs.



**4.5" Weight Post**  
Mount  
for Hexagonal  
Weights#  
#HP-0008-45STAND  
(Use on 66 Frame  
Motors)



**Weight Post Mount**  
for Hexagonal  
Weights  
#HP0008-  
45INCHBRUTE  
Use on 180 Frame  
TEFC Motors



**20# Frame Weight\***  
#HPA0032-2P  
Recommend for 11:1  
XHD Gear Models  
Only

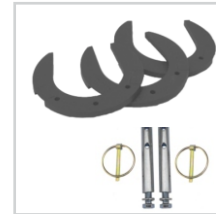

**(1) 25# Horseshoe**  
Wt.  
#HPA0032-1P  
**Mounting Pin Kit**  
#HP0023  
Best when used with  
11:1 XHD Gear



**Vacuum Assembly**  
Kit  
#FM1011



**2.5 Gallon**  
Solution Tank  
#A0001-RAPBLK2.5



**4 Gallon Solution**  
Tank  
7 Stock Colors  
#A0001-Color4



**Osprey Sprayer Kit**  
Motor Mounted  
Solution Sprayer  
Pump,  
2.5 Gallon Solution  
Tank  
#TH1010-BRUTE



**6 Gal. Solution Tank**  
#SME-2QRBLK



**Private Brand**  
Machines  
7 Stock Colors



**Frame Valve**  
for Solution Tank  
for Brute, Merlin,  
TEXHD, Pro, Osprey  
#KIT2061



**Power Lock Kit**  
Locks the Handle  
in the "Up" position  
for Brute, TEXHD  
#HP0005-BLACK





**Floor Prep Tools**



**Surface Prep Scraper**  
(6) replaceable Tungsten Steel Scraping Heads, bolt to steel drive plate. Universal steel clutch plate.  
#HP0035 - 13"  
N/A - 15"  
#HP0033 - 17"  
#HP0034 - 20"



**Orbitec Diamond Driver**  
(6) steel mounting cups hold 3" diamond tools. Universal steel clutch plate.  
#HP0018 - 13"  
N/A - 15"  
#HP0017-3 - 17"  
#HP0020-3 - 20"



**Diamond Pad Driver**  
#A0017DPD - 13"  
N/A - 15"  
#A0010DPD - 17"  
#A0011DPD - 20"

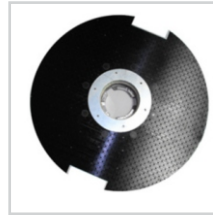

**Weighted Diamond Pad Driver**  
Steel pad driver block adds up to 64 lbs of pressure. Molded pins securely hold pads for HD floor prep.  
#A0017WTDPD - 13" (25#)  
#A0010WTDPD - 17" (46#)  
#A0011WTDPD - 20" (64#)

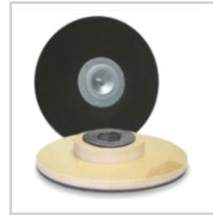

**Premium Sandpaper Driver**  
1" thick plywood block  
1" riser and universal clutch plate.  
1/2" thick cushion and steel mounting disc holds sandpaper  
#A0014-HD - 17"  
#A0014-1HD - 20"



**HAWK Claw Diamond Tool Driver**  
with steel clutch plate  
#CLAW13 - 13"  
#CLAW15 - 15"  
#CLAW17 - 17"  
#CLAW20 - 20"

**Rotary Brushes, Pads, Pad Drivers & Hardware**



**Tampico Polishing / Scrubbing Brush**  
#A0021 - 13"  
#A0035 - 15"  
#A0004 - 17"  
#A0005 - 20"



**Stiff Poly Scrub Brush**  
For general scrubbing  
#A0020 - 13"  
#A0036 - 15"  
#A0002 - 17"  
#A0003 - 20"



**Lite Grit Brush**  
Scrub with flexible blue 150 grit bristles  
#A0018-1 - 13"  
#A0038-1 - 15"  
#A0008-1 - 17"  
#A0009-1 - 20"



**Grit Brush**  
Strip/scrub with stiff black 80 Grit bristles  
#A0018 - 13"  
#A0038 - 15"  
#A0008 - 17"  
#A0009 - 20"



**Nylon Carpet Brush**  
Scrub with soft & stiff nylon bristle mix  
#A0016 - 13"  
#A0037 - 15"  
#A0006 - 17"  
#A0007 - 20"



**HAWK Spin Safe Carpet Brush**  
w/Adjustable S/S Glide Plate  
#A0013-17 - 17"  
#A0013-20 - 20"

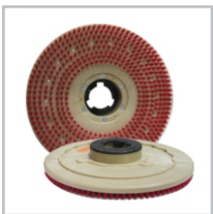

**Tufted Stiff Poly Bristle Pad Driver**  
3/4" long bristles  
3/4" riser  
#1007 - 12"  
#A0018-1 W/R - 13"  
#A0010-4 - 17"  
#A0011-3 - 20"



**Premium Double Hook Pad Driver**  
Molded polymer pad face with individual hooks. Riser and showerfeed block  
#A0017 - 13"  
#A0034 - 15"  
#A0010 - 17"  
#A0011 - 20"



**Hawk Lok™ Pad Driver**  
Molded design with universal clutch plate, built-in riser and a triangular showerfeed system  
#0034-4 - 15"  
#A0010-5 - 17"  
#A0011-4 - 20"

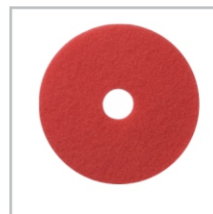

**Red Buffing Pad (5 Pack)**  
Use at 175-600 RPM for everyday cleaning and light scrubbing.  
#A0026-13R-CS - 13"  
#A0026-15R-CS - 15"  
#A0026-17R-CS - 17"  
#A0026-20R-CS - 20"

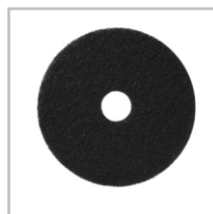

**Black Stripping Pad (5 Pack)**  
Heavy-duty scrubbing and for removal of 2-4 coats of finish/sealer. Washable. Reusable.  
#A0026-13BK-CS - 13"  
#A0026-15BK-CS - 15"  
#A0026-17BK-CS - 17"



**Pad Centering Clamp - 2-Piece**  
2-piece clamp clips together securely holding any size pad.  
#KIT2013 - Screw Lock  
#KIT2014 - Spring Lock

\*Rotary brush blocks are 2" smaller than machine size. Rotary pad driver blocks are 1" smaller than machine size. All have Universal clutch plate.



**HAWK Orbital Floor Machine Accessories**



**Dust Control Kit**  
Skirt and hardware  
#HP0031-DC-  
TIGER2014  
#HP0031-DC-  
TIGER2814



**Dust Control Kit**  
Factory Installed  
Includes 6 qt. Tank  
Vacuum, Dust Skirt,  
Hardware  
#TH1001



**TigerHawk Sprayer**  
**Conversion Kit**  
Factory Installed  
with Motor Mounted  
Pump, 4 Gallon  
Solution Tank &  
Hardware  
#TH1010



**Solution Tank**  
4 Gallon



**Orbital Scrub Brush**  
20" x 14"  
#A0076-2014



**Red Orbital**  
**Scrubbing Pads**  
5 Case



**Black Orbital**  
**Stripping Pads**  
5 Case

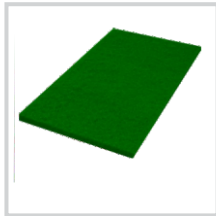

**Green Astro**  
**Textured**  
**Surface Pads**  
2 Case



**Hawk Surface**  
**Prep Pads**  
Maroon  
10 Case

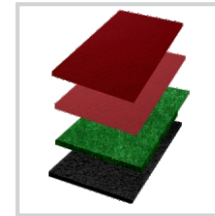

**Orbital Pad Starter**  
**Kit**  
(1) Green, (1) Red  
(2) Black, (2)  
Maroon



**Abrasive Screens**  
10 Case

Orbital Pad Color	10" x 14" for TigerHawk 1410	20" x 14" for TigerHawk 2014 G2 Raptor, Red Tail	28"x14" For TigerHawk 2814
Red (5/cs.)	A0066-1410-CS	A0066-2014-CS	A0066-2814-CS
Black (5/cs.)	A0069-1410-CS	A0069-2014-CS	A0069-2814-CS
Green Astro (4/cs.)	A0072-1410-CS	A0072-2014-CS	A0072-2814-CS
Maroon (10/cs.)	A0064-1410-CS	A0064-2014-CS	A0064-2814-CS
Orbital Starter Kit (1 black, 1 green, 1 red, 2 maroon)	A0075-1410PADKIT	A0075-2014PADKIT	A0075-2814PADKIT
Red Heat Screen 80 Grit	A0074-1410-80	A0074-2014-80	A0074-2814-80
Red Heat Screen 120 Grit	A0074-1410-120	A0074-2014-120	A0074-2814-120
Red Heat Screen 180 Grit	A0074-1410-180	A0074-2014-180	A0074-2814-180



**High Speed Machine Accessories**



**Optional Splash Guard**  
#SPLASH13 - 13"  
#SPLASH15 - 15"



7 Private Brand Colors  
Plus Chrome



**Dust Ring and Dust Filter Kit**  
for DC Burnishers  
#HPA0029-2KIT



**Dust Filter**  
#A00029-2



Burnishers Include Flexible Pad Driver with Centering Clamp



**Hogs Hair Burnishing Pads**  
(5 Pack)  
#A0025-13P-CS - 13"  
#A0025-15P-CS - 15"  
#A0025-16P-CS - 16"  
#A0025-17P-CS - 17"  
#A0025-19P-CS - 19"



**White Polishing Pads**  
(5 Pack)  
#A0025-13P-W - 13"  
#A0025-15P-W - 15"  
#A0025-16P-W - 16"  
#A0025-17P-W - 17"  
#A0025-19P-W - 19"



**Pad Centering Clamp - Screw Mount**  
#KIT2013



**Pad Centering Clamp - Spring Mount**  
#KIT2014



# HAWK ENTERPRISES



**Rotary Floor Machines • Orbital Floor Machines • Burnishers • Cleaning Equipment**

• **HAWK ENTERPRISES**

**2902 Park Six Court, Elkhart, IN 46514**

• **(574) 294-1910**

**[www.hawkenterprises.com](http://www.hawkenterprises.com)**